

INCLUDING
*Communication
Engineering*
and
*TV & RADIO
ENGINEERING*

RADIO-ELECTRONIC *Engineering*

Reg. U. S. Pat. Off.

AUGUST, 1954

DESIGN OF STUDIO AUDIO SYSTEMS
7

TRANSMISSION AND POWER LEVELS
IN MULTIPLEX EQUIPMENT
10

RESPONSIBILITIES OF
INDUSTRIAL RADIO LICENSEES
12

INSTRUMENT METHODS
IN AERIAL SURVEY
13

AUDIO AND R.F.
SECONDARY FREQUENCY STANDARD
16

CINCINNATI TV CONFERENCE
20

DEPARTMENTS

COMMUNICATION REVIEW	22
NEWS BRIEFS	24
NEW TUBES	26
TECHNICAL BOOKS	30
NEW PRODUCTS	32
NEW LITERATURE	34
CALENDAR	35
TV-AM-FM PRODUCTION	36
PERSONALS	38

Inside view of the mobile television laboratory set up by the engineering division of *Motorola, Inc.*, Chicago, Ill. Each new development in color and u.h.f. television is pretested extensively "on location" under a wide variety of operating conditions.

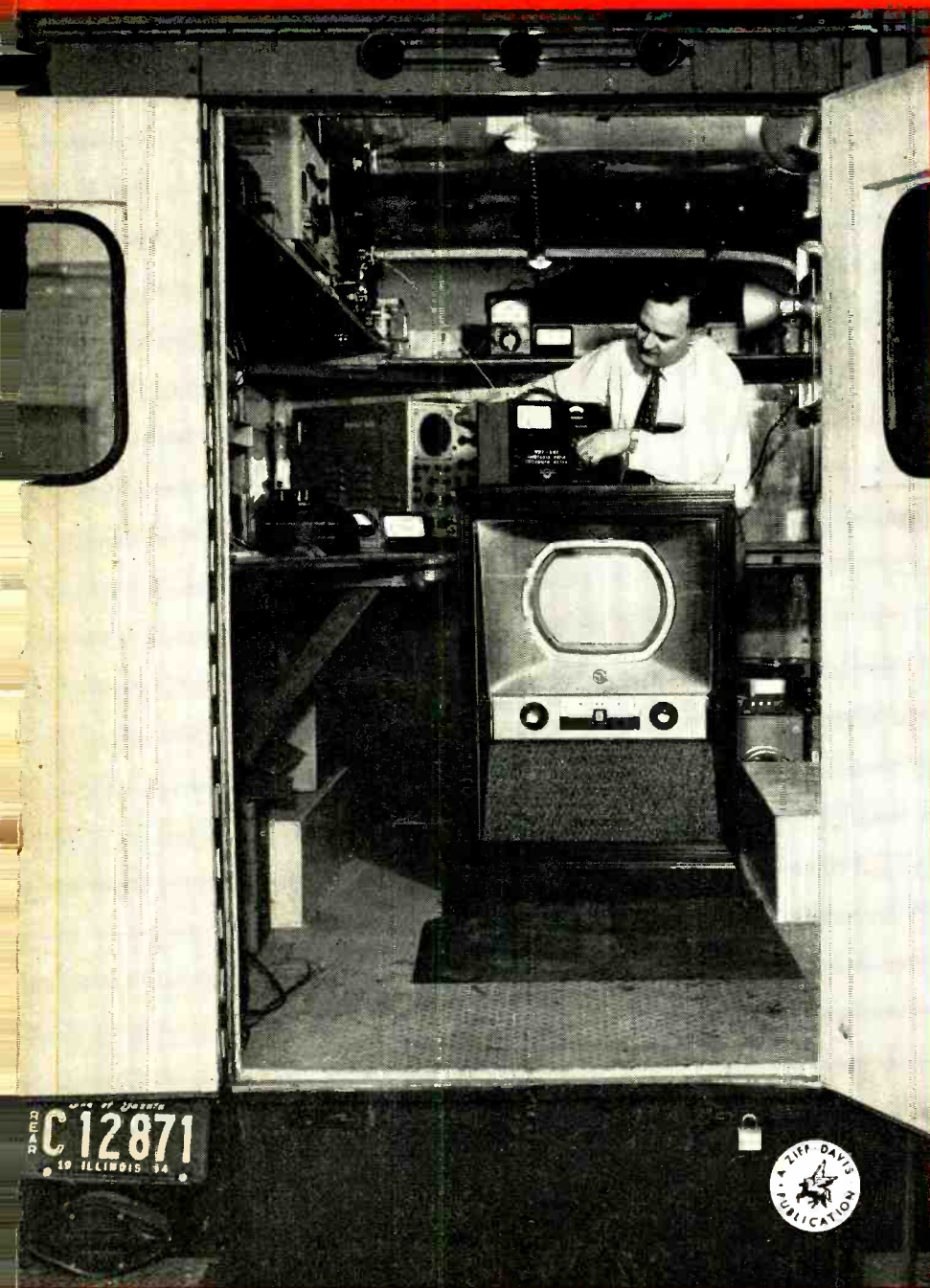

MADE IN U.S.A.
C 12871
19 ILLINOIS 54



TELEVISION • ELECTRONICS • COMMUNICATIONS • AUDIO • MICROWAVES • RADAR • RESEARCH

HIGHEST FIDELITY

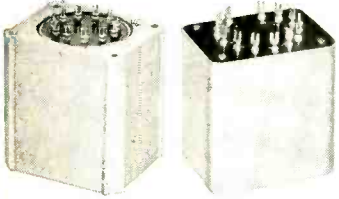

Linear Standard

Hipermalloy



TRANSFORMERS REACTORS · FILTERS

FROM STOCK...

COMPACT

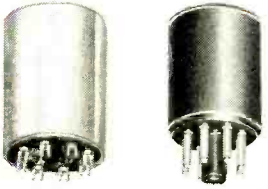

Ouncer

Plug-In



Magnetic Amplifiers



Multi-Shielded Inputs

AMATEUR MINIATURE



Special Series

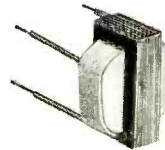

Sub-Ouncer



Inductors

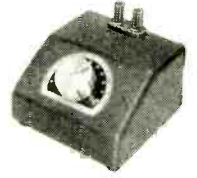

Decades

HI-Q TOROIDS

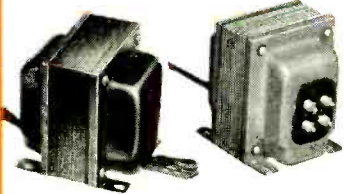

Replacement

Signaling and Control

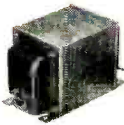

Stepdown



Line Adjustors

CONTROLLED RESPONSE



Filters



Equalizers

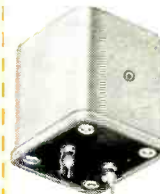

Non-Hermetic



Hermetic

VARIABLE INDUCTORS

RUGGED... INDUSTRIAL



Plate



Audio

TO SPECIFICATIONS...

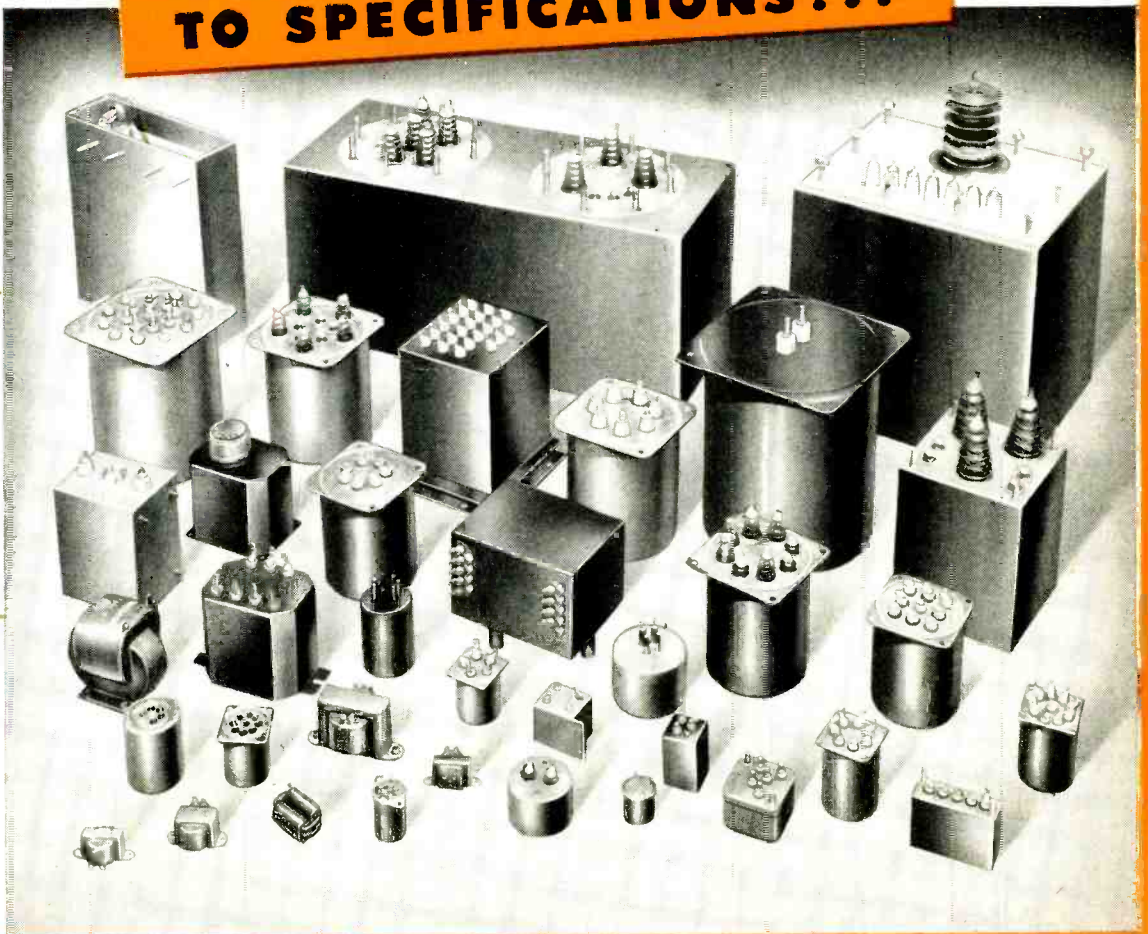

HIGHEST FIDELITY

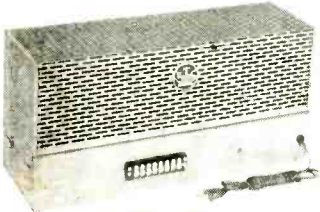

Amplifier Kit

HERMETIC... MIL-T-27



Audios



Pulse Units

UNITED TRANSFORMER COMPANY • 150 VARICK STREET, NEW YORK 16, N. Y.

EXPORT DIVISION: 13 EAST 40th STREET, NEW YORK 16, N. Y. • CABLES: "ARLAB"

Eimac Klystron Report

Ruggedized X Band local oscillator reflex klystrons

1K015XA • coaxial output
1K015XG • waveguide output

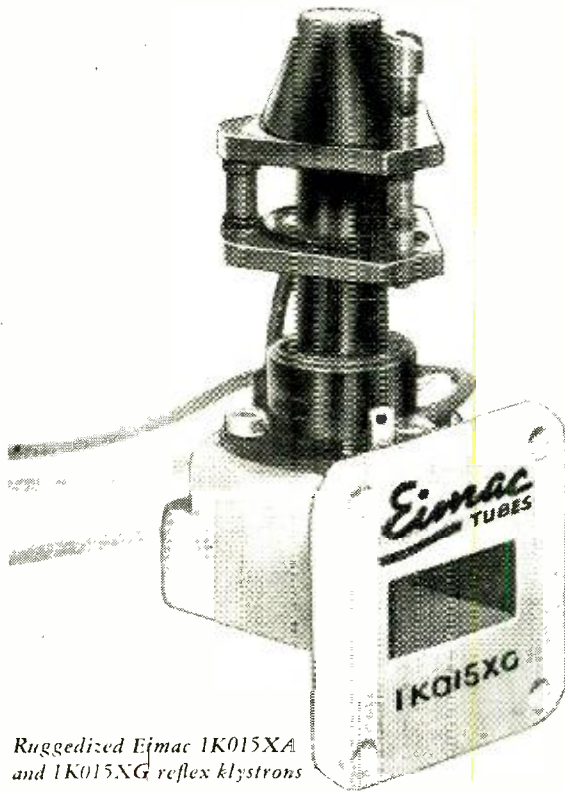

Ruggedized Eimac 1K015XA and 1K015XG reflex klystrons

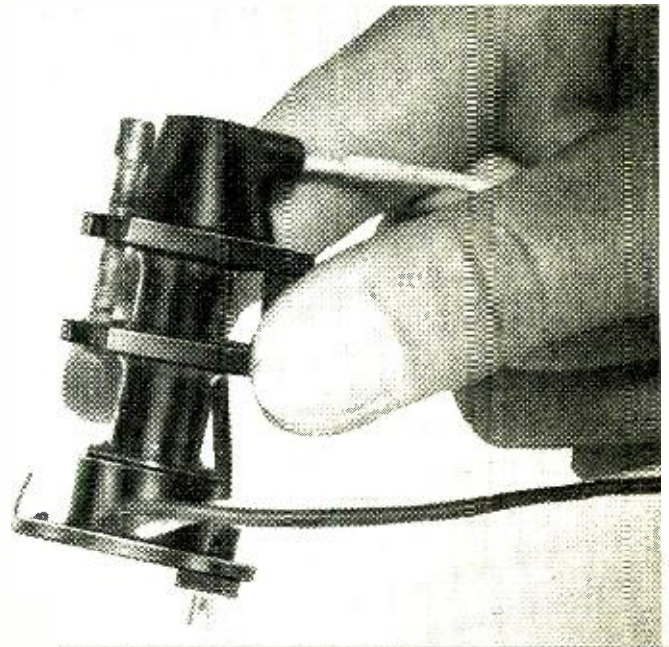

TYPICAL OPERATION (with flat load)

1K015XA and 1K015XG KLYSTRONS

MODE	73.4	5.5/4
D-C Resonator Voltage	250	300
D-C Cathode Current	30	47
D-C Repeller Voltage	-65	-170
Power Output	30	100
Frequency	9000	9000
Electronic Tuning Range	55	40

Reliable X band performance through the **VAST*** punishment of airborne environment plus the features of single adjustment tuning and rapid production are offered only in Eimac 1K015XA and 1K015XG local oscillator reflex klystrons.

- ***VIBRATION**—withstands 10G's of continuous vibration.
- ***ALTITUDE**—arc-guard protection of leads eliminates possibility of flash-over at extremely high altitudes.
- ***SHOCK**—withstands 100G's of impact shock.
- ***TEMPERATURE**—maintains frequency stability through a temperature variation of -20° to 80° C.

RAPID PRODUCTION—simplified design permits rapid, low cost production.

RELIABLE PERFORMANCE—25 to 100 milliwatts power output from 8400 to 9600mc with low power consumption—plus assurance of uncompromising Eimac quality proved through 20 years of electron-power tube design and manufacture.

SINGLE TUNING—one-adjustment tuning without the use of lock nuts.

- For further information about the 1K015XA, 1K015XG or any of the complete line of Eimac klystrons, including high power UHF-TV amplifiers, contact our Technical Services department.

EITEL-McCULLOUGH, INC.
SAN BRUNO • CALIFORNIA

Eimac
THE WORLD'S
LARGEST MANUFACTURER OF
TRANSMITTING TUBES

MINIATURIZING YOUR EQUIPMENT?



Specify *SIMPLEST, MOST COMPACT*

AMPERITE THERMOSTATIC DELAY RELAYS

MOST ECONOMICAL, HERMETICALLY SEALED



STANDARD



MINIATURE

Provide delays ranging from 2 to 120 seconds.

• Actuated by a heater, they operate on A.C., D.C., or Pulsating Current.

- *Hermetically sealed.* Not affected by altitude, moisture, or other climate changes.
- Circuits: *SPST only* — normally open or normally closed.

Amperite Thermostatic Delay Relays are compensated for ambient temperature changes from -55° to $+70^{\circ}$ C. Heaters consume approximately 2 W. and may be operated continuously. The units are most compact, rugged, explosion-proof, long-lived, and — *inexpensive!*

TYPES: Standard Radio Octal, and 9-Pin Miniature.

PROBLEM? Send for Bulletin No. TR-81

BALLAST-REGULATORS

- **Amperite Regulators** are designed to keep the current in a circuit *automatically regulated* at a definite value (for example, 0.5 amp).
- For currents of 60 ma. to 5 amps. Operates on A.C., D.C., Pulsating Current.
- Hermetically sealed, light, compact, and most inexpensive.

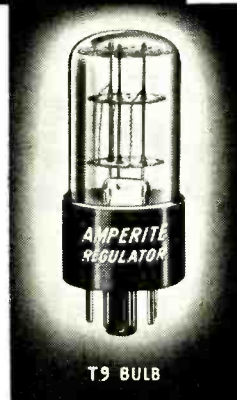
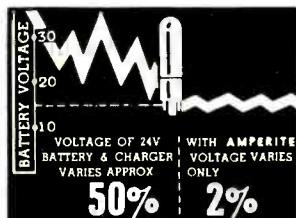
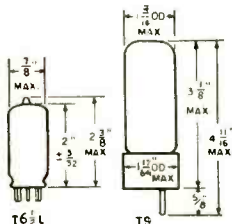

T9 BULB

Maximum Wattage Dissipation: T6 1/2 L—5W. T9—10W.

Amperite Regulators are the simplest, most effective method for obtaining *automatic regulation* of current or voltage. *Hermetically sealed*, they are not affected by changes in altitude, ambient temperature (-55° to $+90^{\circ}$ C), or humidity. Rugged; no moving parts; changed as easily as a radio tube.

Write for 4-page Technical Bulletin No. AB-51

AMPERITE CO. Inc., 561 Broadway, New York 12, N. Y.

In Canada: Atlas Radio Corp., Ltd., 560 King St. W., Toronto 2B

RADIO-ELECTRONIC *Engineering*

INCLUDING

*TV & RADIO & Communication
ENGINEERING Engineering*

Edited by H. S. RENNE

and the Radio & Television News Staff

VOLUME 23

NUMBER 2

Editor and Asst. Publisher

OLIVER READ, D. Sc., WIETI

Managing Editor

WM. A. STOCKLIN, B. S.

Technical Editor

H. S. RENNE, M. S.

Assistant Editor

M. C. MAGNA

Art Editor

FRANK SAYLES

Draftsmen

ALBERT A. GANS
JOSEPH A. GOLANEK

Advertising Manager

L. L. OSTEN

Midwest Adv. Manager

JOHN A. RONAN, JR.

Western Adv. Manager

JOHN E. PAYNE

ZIFF-DAVIS PUBLISHING COMPANY

WILLIAM B. ZIFF (1898-1953) FOUNDER

Editorial and Executive Offices
366 Madison Ave., New York 17, N. Y.

President

B. G. DAVIS

Vice-Presidents

H. J. MORGANROTH
M. H. FROELICH

Secretary-Treasurer

G. E. CARNEY

Circulation Manager

M. MICHAELSON

BRANCH OFFICES

CHICAGO (1): 64 E. Lake St.

LOS ANGELES (14): 900 Wilshire Blvd.

RADIO-ELECTRONIC ENGINEERING is published each month as a separate publication and is available by subscription only when purchased with a subscription to RADIO & TELEVISION NEWS.

(Average Paid Circulation Over 28,000)

Copyright 1954 by Ziff-Davis Publishing Company
(All Rights Reserved)

...how good is
BEST?



BEST

... By *TEST!*
... By *PERFORMANCE!* *

These curves are authentic recordings taken from actual results obtained from a nationally known independent testing laboratory.

and here's proof!

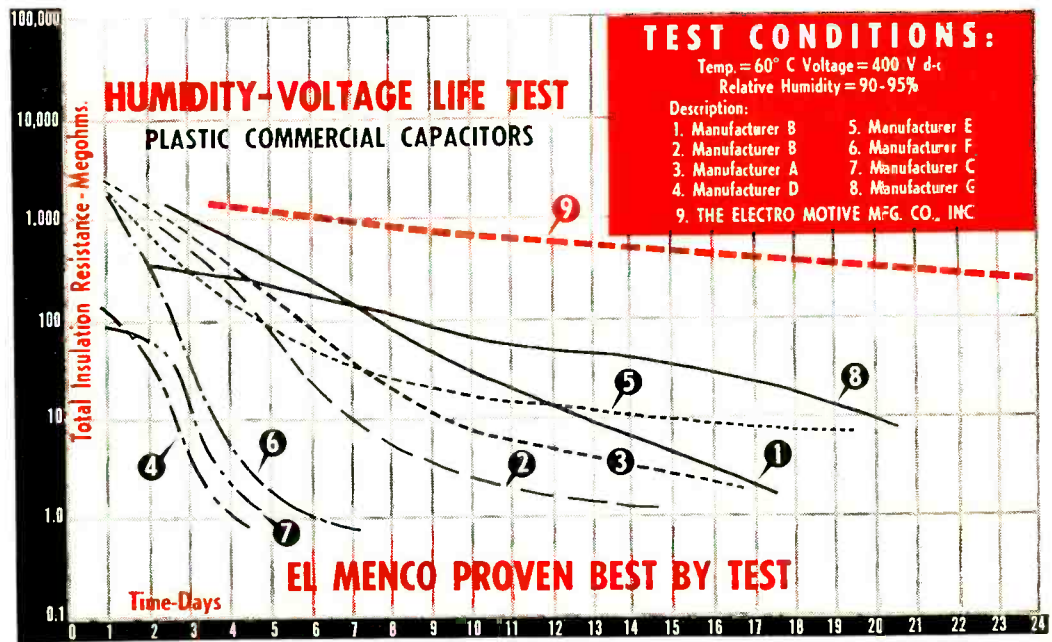

* CERAMIC CASED PAPER DIELECTRIC CAPACITORS —

* More than 60 million of these capacitors have been used by nationally known radio and television manufacturers with no reported field failures. These ceramic capacitors are available in 200, 400, 600 and 1000 working voltage ratings.

Write for sample and catalog on your firm's letterhead.



Jobbers and Distributors are requested to write for information to Arco Electronics, Inc., 103 Lafayette St., New York, N. Y.

MOLDED MICA El-Menco MICA TRIMMER CAPACITORS

Foreign Electronic Manufacturers Get Information Direct from our Export Dept. at Willimantic, Conn.

THE ELECTRO MOTIVE MFG. CO., INC.

WILLIMANTIC, CONNECTICUT

What means most to an Engineer?



PROFESSIONAL
RECOGNITION



GOOD
SALARY



UNEXCELLED
FACILITIES



SUBURBAN
LIVING

RCA offers all These...and more!

RCA offers career opportunities for qualified **ELECTRICAL** and **MECHANICAL ENGINEERS** . . . **PHYSICISTS** . . . **METALLURGISTS** . . . **PHYSICAL CHEMISTS** . . . **CERAMISTS** . . . **GLASS TECHNOLOGISTS**.

Positions now open in Systems, Analysis, Development, Design and Application Engineering. Your choice of long range work in commercial or military fields. At RCA you'll work in an atmosphere conducive to creative work — laboratory facilities unsur-

passed in the electronics industry . . . constant association with leading scientists and engineers.

Delightful suburban living easily available. Modern retirement program . . . liberal tuition refund plan for advanced study at recognized universities . . . modern company paid benefits for you and your family.

Individual accomplishments readily recognized. Ample opportunity for increased income and professional advancement.

Join the team at RCA and grow with the world leader in electronics.

Personal interviews arranged in your city.

Please send a complete resume of your education and experience to:

MR. JOHN R. WELD

Employment Manager, Dept. 304H
Radio Corporation of America
30 Rockefeller Plaza, New York 20, N.Y.



RADIO CORPORATION of AMERICA

Tmks. ®

**SYSTEMS—ANALYSIS—DEVELOPMENT—
DESIGN—APPLICATION ENGINEERING**
in the following fields:

AVIATION ELECTRONICS (FIRE CONTROL, PRECISION NAVIGATION, COMMUNICATIONS)—
Radar—Analog Computers—Digital Computers—Servo-Mechanisms—Shock & Vibration—Circuitry—Heat Transfer—Remote Controls—Sub-Miniaturization—Automatic Flight—Transistorization—Automation

RADAR—Circuitry—Antenna Design—Servo Systems—Information Display Systems—Gear Trains—Stable Elements—Intricate Mechanisms

COMPUTERS—Digital and Analog—Systems Planning—Storage Technique—Circuitry—Servo-Mechanisms—Assembly Design—High Speed Intricate Mechanisms

COMMUNICATIONS—Microwave—Aviation—Mobile—Specialized Military Systems

MISSILE GUIDANCE—Systems Planning and Design—Radar and Fire Control—Servo-Mechanisms—Vibration and Shock Problems—Telemetry

COMPONENT PARTS (COLOR & MONOCHROME TV)—HV Transformers—Coils—Deflection Yokes

SEMI-CONDUCTORS—Transistors—Diodes

ELECTRON TUBE DEVELOPMENT—Receiving—Transmitting—Cathode-Ray—Phototubes and Magnetrons—Power Tubes—Camera Tubes

ELECTRONIC EQUIPMENT FIELD ENGINEERS—Specialists for domestic and overseas assignment on military electronic Communications, Navigational Aids, and Guided Missiles.

DESIGN OF STUDIO AUDIO SYSTEMS

DESIGN of a studio audio system can be greatly simplified by using the modern gain "packages" provided by plug-in amplifiers. Experience in setting up broadcast installations has shown that a 100% plug-in installation costs no more than a conventional amplifier arrangement and only requires about two-thirds of the space.

Space and Maintenance

In a studio layout, particularly for a TV studio, space for operating equipment must be carefully allotted. As the TV show is generally more complex than most radio shows, this usually means more microphones and therefore more preamplifiers. Space limitations are partly responsible for the growing popularity of small, compact amplifiers. While the same advantages would accrue under normal conditions, the present squeeze on space points these units up as virtual lifesavers. Plug-in audio equipment for a typical TV studio will generally require only about one-half the rack space used by conventional rack-mounted amplifiers.

Use of plug-in amplifiers makes maintenance easy by allowing a defective unit to be replaced in a matter of seconds without any tools, and the repair of the defective unit can be made conveniently at the workbench. This ease of replacement minimizes jack field requirements, further reducing space demands. While plug-in amplifiers cannot surpass the efficiency of a jack field for trouble-shooting, once the defective amplifier is located it can be quickly replaced and does not have to be "patched-around" until repaired.

Equipment

The new plug-in amplifiers made by the *General Electric Company* for broadcast studio use require little space and are designed for easy maintenance. The complete plug-in line consists of the Type BA-1-F preamplifier, the Type BA-12-C program/monitor amplifier, and the Type BP-10-B power supply, all designed to mount on the Type FA-23-A shelf, which requires but seven inches of rack space (Fig. 2).

Preamplifier

Electrically, the Type BA-1-F preamplifier (Fig. 3) is a two-stage amplifier using an output transformer having a tertiary feedback winding which provides approximately 25 db of feedback to the cathode of the first stage. Thus, the only component outside the feedback winding is the input

By **BARD E. ZWAYER**

General Electric Company

Typical console design incorporates plug-in preamplifiers, amplifiers and power supplies.

transformer—a passive linear element which does not change with time. The input transformer is designed to work from 30/150/250/600-ohm sources, and the output transformer may be strapped for 150- or 600-ohm loads.

Practically all preamplifiers operate with unloaded input transformers and are therefore rated as operating from a certain source impedance, since the actual input impedance is the rather high impedance of a transformer with the secondary terminated by the grid input impedance of a tube. Therefore, the full generated voltage of a microphone appears at the transformer, giving the maximum signal-to-noise ratio from the microphone. The 150-ohm tap on the input transformer gives approximately a 20 to 1 voltage step-up, bringing the signal still further above the tube noise level.

By using an output transformer having a tertiary winding, not only is the output transformer included inside the feedback loop but a much higher B+ ripple can be tolerated than if plate feedback were used. Frequency response is flat within ± 1 db from 50 cps to 15 kc., distortion from 50 to 15,000 cps is less than $\frac{1}{2}\%$ at the rated output of +18 dbm, and the gain is 40 db with

an equivalent input noise of approximately -120 dbm. The two tubes used are the new type 5879 miniatures especially designed for low microphonics and low noise. To minimize the effect of heater-cathode leakage, the heaters are biased at +30 volts, assuring that a majority of tubes taken at random can be used in the most critical applications.

Program/Monitor Amplifier

Electrically, the Type BA-12-C program/monitor amplifier consists of one type 5879 amplifier stage, a type 5879 cathodyne split-load phase inverter and a pair of 6V6 output tubes. A toggle switch is incorporated which will decrease the feedback by 15 db for high-gain loudspeaker applications. In the low-gain position, the amplifier has a gain of 56 db and is rated at 8 watts (+39 dbm) for less than 1% distortion and 1 watt (+30 dbm) at less than $\frac{1}{2}\%$ distortion. Frequency response is flat ± 1 db from 50 cps to 15 kc., and noise output is less than -60 dbm.

The high-gain (71-db) position is quite useful for nonprogram applications such as monitoring a low-level line. By replacing the 6V6 tubes with 5881's or 6L6's and increasing the B+ supply voltage, the amplifier gives very

Fig. 1. The G-E BC-11-A broadcast audio console, which uses the plug-in preamplifiers and amplifiers described in the text.

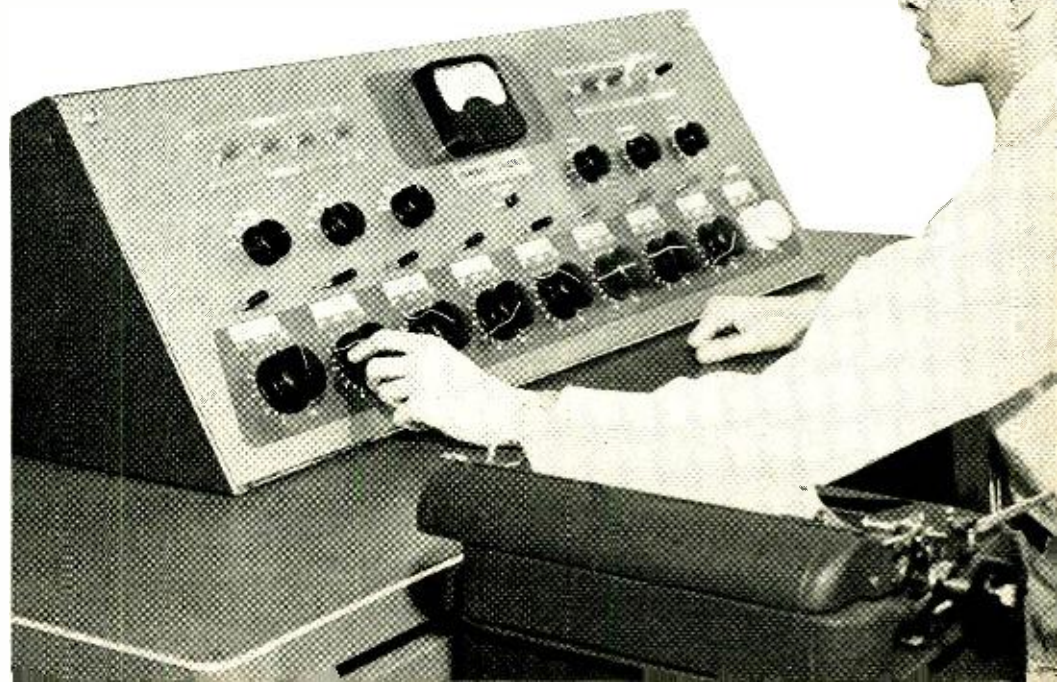



Fig. 2. Rack containing preamplifier (left), program/monitor amplifier (center), and power supply (right).

good performance at levels of 15 watts or more. Thus, the same type of amplifier can be used even for talking back to large studios where the noise level is quite high.

This amplifier is designed to operate from sources of 30/150/250/600 ohms and to feed loads of 150 or 600 ohms. A tertiary feedback winding on the output transformer includes everything but the input transformer in the feedback loop. Approximately 20 db of inverse feedback is used in the low-gain position.

The compactness and flexibility of this equipment is typified by the *General Electric* audio console Type BC-11-A (Fig. 1), which uses the plug-in units exclusively.

Typical System Design

Assume that it is desired to have five microphone inputs with submaster operation, an announce microphone, two turntable inputs, a network input, and a remote or "nemo" input. Several remote lines are generally wired in permanently and the desired one selected by a lever key switch, a push-button switch, or a rotary switch. Figure 4 shows all the inputs mentioned above connected so that they may be mixed

and passed to the output line with all levels under control. Figure 4 also shows the vu meter and monitoring amplifier, but it does not include any of the main program amplifiers. How these amplifiers may be inserted and the circuit built up to provide all elements of proper operation will be described in detail.

Either vu or dbm may be used to show levels on a single line diagram, but the relationship must be kept in mind in selecting amplifiers. VU meter ballistic characteristics are such that on average program material peaks are present which are 10 db higher in level than the meter reads. Equipment used for program material must be rated to handle these peaks of power. A zero vu program level, therefore, is equivalent to a peak power level of +10 dbm'. This article will use vu levels, as the use of vu gives a more realistic (though poorer) signal-to-noise ratio. (The FCC specifies tone-to-noise ratio in its regulations.)

Microphone Preamplification

System design usually assumes an average microphone output of -60 vu. At the preamplifier input, a -50 dbm tone signal could be applied for test purposes as this would give the same peaks. Most preamplifiers have input noise ratings of -120 dbm. Thus, there will be a tone-to-noise rating of 70 db. Using the vu level, the signal-to-noise rating is then only 60 db. So long as the signal level is not allowed to fall below about -54 vu (6 db above microphone level), noise will not be a problem, as input noise will determine the noise level. The noise level of the program amplifier that will be used is -60 dbm at the output. Consequently, with an output level of +18 vu, signal-to-noise ratio will be 78 db, which is much better than the 60 db established at the preamplifier.

It is not unusual for a microphone (such as the boom microphones used in

television) to put out signals as high as -35 vu in loud sound fields or as low as -85 vu in weak sound fields. An input signal of -35 vu drives the output of the preamplifier to much higher power levels, while the -85 vu signals give signal-to-noise ratios of only 35 db.

Since the special low-noise preamplifier tubes that have been designed in order to reach the -120 dbm noise level will develop undistorted (1/2%) power outputs of only about +18 dbm, the gain of the preamplifier should be such that the loud input levels do not overload the circuit. Taking -25 dbm (-35 vu) as the input and +18 dbm as the output, the gain should be 43 db. For flexibility in design, gains of about 40 db also enable control, mixing, etc., to be handled at convenient power levels with preamplifiers having an economical B+ drain. Only where an unusually large number of mixer inputs is required does a higher gain—higher power preamplifier become beneficial; in such cases, the output of the mixer network approaches or becomes lower than the preamplifier input and thus degrades the signal-to-noise ratio. If an output tube is added in order to have a higher power output, the gain must also be increased to prevent the noise from becoming a problem.

Normally, the program level fed to the output line is +8 vu, and it is fed through a 6- or 10-db pad. For the present illustration, a 10-db pad will be used. This pad is necessary in order that the vu meter which precedes it will read properly and so that the phone line will be fed from a substantially constant impedance source. Hence, the line or program amplifier must put out a +18 vu program level, and the amplifier output rating must therefore be +28 dbm. Actually, the amplifier should be capable of handling a few db above this level to allow for occasional bursts—indicating that an amplifier having a program rating of +30 dbm should be used.

Getting back to the system design of Fig. 4, the preamplifiers and a program amplifier should be inserted and the levels extended as shown in Fig. 5. The system will be properly designed when all necessary controls are inserted and these levels are equal. A level of -20 vu out of the microphone preamplifiers now exists and a level of -38 vu into the program amplifier is required.

Faders

Before proceeding further, the type of controls to be used must be determined. Generally, mike faders are 20-step controls, 2 db per step, tapered to infinity without detents. The usual types are H, T and balanced and unbalanced ladders. The H and T controls

Fig. 3. Schematic diagram of the G-E Type BA-1-F preamplifier.

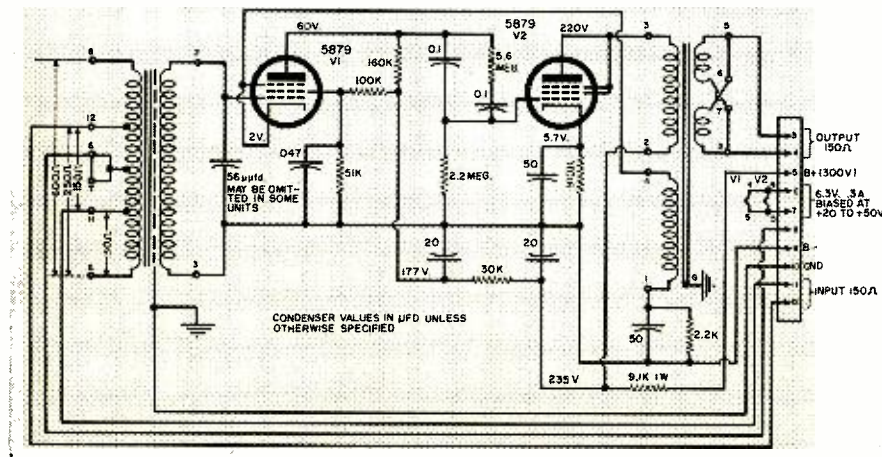

TRANSMISSION AND POWER LEVELS IN MULTIPLEX EQUIPMENT



Terminal equipment for a multi-channel radio system; carrier telephone system is on left, a duplex radio assembly on right.

INCREASING use of multichannel radio systems has made necessary closer cooperation between communications engineers of the telephone and radio industries. The frequency-division multiplex equipment now being used in ever greater quantities for channelizing v.h.f. radio and microwave systems was basically designed and has been used for many years by the telephone industry. Since the radio and telephone industries developed somewhat independently, these industries sometimes use different definitions for the same term. One of the most important examples of this difference in meaning is the use of the word "level." To a telephone man this word means "transmission level," while to the radio man it means "power level." Although the two types of level are closely related, there is a distinct difference between them. Distinctions between power levels and transmission levels are particularly important when signals passing through a circuit or device are amplified or attenuated by different amounts, as in a compander.

Power Level

Through common engineering usage, the word "level" has been accepted as a relative indication of either the amount or amplitude of some quantity. The word "power" alone, as defined in electrical textbooks, refers to the rate of energy consumption or the rate of doing work.

If power is the rate of energy consumption, power level can be considered to be the rate of energy flow. The amount of current flowing can be measured at any point in a circuit, and the voltage across the circuit at such a point can also be measured even though none of the energy is being consumed at that point. Therefore, the product of voltage and current at a particular point is the rate of energy flow.

Power level, when considered in this manner, is a measure of the amount of power passing a given point in a circuit. It is equal to the amount of power which would be consumed if the circuit were terminated at that point. When a steady tone is inserted and transmitted through a circuit, the attenuation or gain between points can be determined easily by measuring the power levels at those points.

For convenience in use, power levels are usually expressed in decibels above or below a reference power value. In telephone work, the standard reference is 1 mw., usually stated as 0 dbm. A power level of 10 mw., which is 10 db greater than 1 mw., is stated as +10 dbm. Other reference powers are widely used in other branches of communications. Engineers working with microwave radio systems, for example, often use 1 watt as a standard reference power and express transmitted and received power levels in dbw (db above or

below 1 watt). Broadcast radio engineers sometimes express power levels in dbk (db above or below 1 kw).

The reference of 1 mw. for the telephone field proves very convenient since this amount of power is close to the maximum amount of speech power normally delivered to a line from a telephone set transmitter.

Transmission Level

It is often desirable to know how much gain or loss exists between various circuit points in all types of electrical circuits. This enables engineers to plan circuits so that the proper amounts of power are available when needed. In electric power distribution circuits and in many types of radio communication circuits, the amounts of power passing any particular point remain relatively constant. Since gains and losses are shown by the differences in power level, engineers working with these circuits deal constantly with power levels and have come, quite naturally, to abbreviate the term to the single word "level."

Telephone circuits, however, do not transmit constant amounts of power. Instead, the power level at any point in a telephone circuit varies continually as different talkers speak different words. Since power levels in a telephone circuit are difficult to measure when speech is being transmitted, telephone engineers developed a new term—trans-

By **WESTON C. FISHER**

Lenkurt Electric Co., Inc.

The term "level" can have a very different meaning for a telephone engineer than for a radio engineer. Distinctions between the two "levels" are discussed.

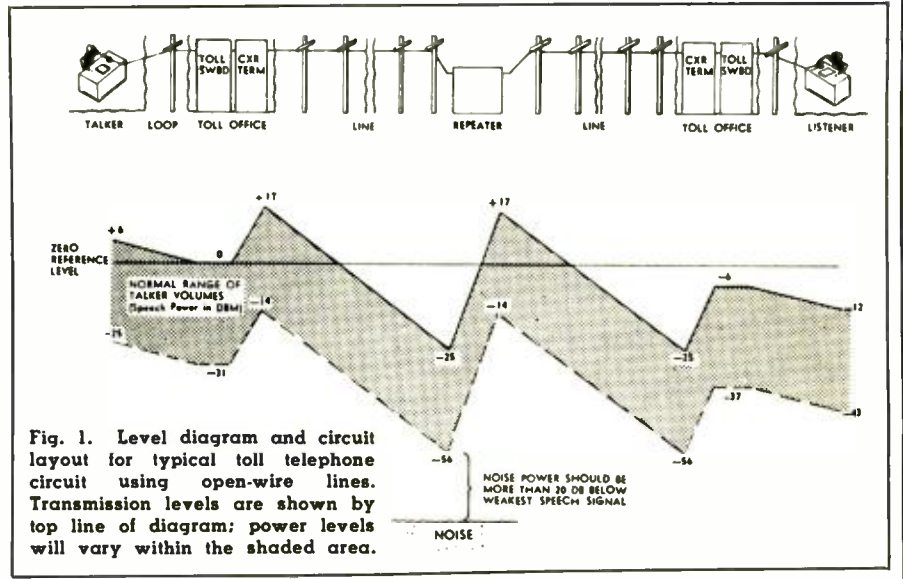

Fig. 1. Level diagram and circuit layout for typical toll telephone circuit using open-wire lines. Transmission levels are shown by top line of diagram; power levels will vary within the shaded area.

mission level—to indicate gains and losses between various circuit points. And just as power and radio engineers abbreviate "power level" to "level," telephone engineers abbreviate "transmission level" to "level." For the balance of this article, the word "level" when used alone, will always indicate transmission level.

Level, in telephone usage, is a purely relative term. Stating that a certain circuit point is at a certain level indicates only how much attenuation or gain there is between that point and a zero reference level point; no specific amount of power is indicated. Since level is a relative rather than an absolute term, as is the case with power or power level, a circuit point always remains at the same level unless additional gains or losses are inserted between that point and the zero reference level point. The power level at the circuit point will vary with speech. Unless some other reference is stated, the zero reference level for a signal in a telephone circuit is the two-wire input to the transmitting toll switchboard.

The concept of level, and the difference between level and power level of the transmitted speech, is illustrated in Fig. 1, which comprises a diagram

showing both transmission level and the range of power levels of transmitted signals at various points in a typical toll circuit using an open-wire line. In this level diagram, the top line shows the amount of gain or loss existing between the various points in the complete toll circuit; it is a graph of transmission level. The shaded portion shows the range of power levels which the speech transmitted over the circuit will have. The power level at any point in the circuit at any particular time will depend upon the talker and the words spoken, and will not necessarily be the same as the transmission level at that point. A similar diagram could be constructed for toll telephone channels transmitted over a radio system.

At all specified points, the transmission level is given as so many decibels above or below the zero reference level, and is an indication only of how much gain or loss the transmitted signals have received between the various points along the transmission path.

Test Tone Power

Since both power levels and transmission levels are dependent on the gains and losses in the circuit, it is convenient to adjust equipment for desired transmission levels by measuring

the power level of a standard test tone. When telephone carrier systems are adjusted or "lined-up," a standard test tone is inserted at the transmitting end of the system. Then, the gains and losses of various pads and amplifiers in the equipment are adjusted to obtain the desired test tone power level at specified circuit points. A 1000-cps test tone with a power of 1 mw. is ordinarily available at toll test boards. When this test tone is transmitted over a telephone circuit, the test tone power in dbm at any point in the circuit is numerically equal to the level in db at that point.

In laying out telephone circuits, it is necessary to know the net loss which the circuit will give to speech currents passing through it. It is neither necessary nor practical in this type of planning to know exactly what the actual power will be at any point. The normal range of speech power level transmitted over a telephone circuit is shown in Fig. 1. Since the gain or loss of a circuit is independent of power (within the power-handling capacity of the equipment), it is convenient to have the concept of level to express the relative strength of a signal at any point and to determine net gain or loss

(Continued on page 28)

Fig. 2. Typical test tone power levels in a carrier circuit arranged for channelizing a microwave radio system.

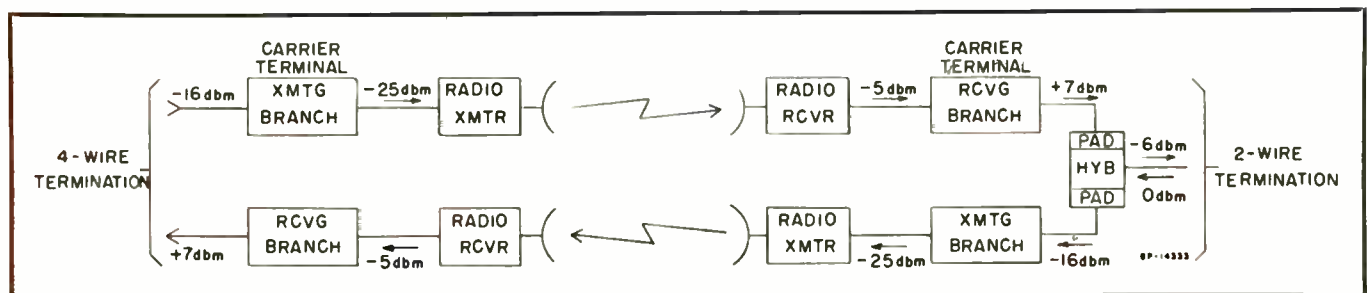

RESPONSIBILITIES

OF INDUSTRIAL RADIO LICENSEES

By **LESTER W. SPILLANE**, Federal Communications Commission

Competition for spectrum space among industrial radio users calls for recognition of the regulatory problems involved.



"I HAVE BEEN asked to explore, in some degree, relationships between common carriers and private users in the radio communications field. This subject appears pertinent, inasmuch as there are growing competitions and areas of overlapping operations affecting the future of both. In attempting this examination, it must be fully understood that I cannot—and will not—draw any conclusions or inferences as to the superiority of one of these methods of providing communications over the other. Nor do I intend to suggest that the owners of industries such as yours should not make their own judgments as to the communications resources on which they are willing to rely. We are all aware, however, of the fact that over the years the Commission has made basic public interest determinations having the effect of recognizing the need of various private users for their own direct radio communications facilities.

"The expansion in mobile radio use since World War II has been accompanied by the most intense kind of competition for spectrum space. Despite the basic decisions reached by the Commission in 1945 and 1949 as to division of allocations, this competition has not really lessened. Only last year, the Commission was brought to consider for the second time whether the telephone company "broadband" request for vastly increased common carrier mobile space could be accommodated between 216 and 470 mc. (Docket 10,323). This involved, among other things, the direct question of whether common carrier allocations in the 450-460 mc. band should be increased. The Commission, though not unsympathetic to the needs of the carriers and the frequency utilization promise of this proposal, was unable to find that the request should be accommodated at the consequential expense of drastically decreasing the allocations for the various safety and special services having previously been given final allocations in this part of the spectrum.

Editor's Note: This talk was given by the author at the Petroleum Industry Electrical Association Meeting in Dallas, Texas, April 6, 1954. Mr. Spillane is Assistant Chief of the Safety and Special Radio Services Bureau of the FCC.

These natural compulsions toward growth of all users take various forms, and though sometimes seeming dormant, they are ever present, ever alive and ever powerful. The present need and impulse to exploit the microwaves serves to focus anew the tendency of these forces to expand, and to emphasize the necessity for farsighted answers to the problems they generate.

"In our appearances before your group in prior years, we have discussed mainly the technical questions involved in microwave developments. All of us have recognized the basic pressures for the emergence of adequate technical standards to permit efficient, coordinated utilization of this part of the spectrum. We have come to realize that even in this sense our task involves new kinds of problems. Restrictions against domestic point-to-point operations are apparently not to be applicable in this part of the spectrum. On the other hand, the difficulties of providing feasible means of coordinating multiple and divergent private uses have troubled everyone. These symptoms of growth have impelled manufacturers, users, and the Commission's staff to cooperate in efforts to build a stable foundation for microwave operations, expressed in particular rules and standards. Adequate knowledge of basic technical facts and considerations is an essential prelude to the drawing of such standards. We have, therefore, joined in the devising of questionnaires to elicit the technical data required to underlie sound rules. We will complete these steps and convert the resultant data into standards as rapidly as we possibly can. Not that the microwave prob-

lems will be solved by technical means alone; what happens in these connections may very well turn as much on economic, social, and philosophical factors as on engineering considerations. But adequate standards are vital in the sense that they are needed to provide the blueprints essential for feasible functioning of private users in the microwaves.

"While we are thus endeavoring to produce uniform microwave standards, pressures to reach partial decisions in this area continue. You probably know of the pending rule making proposal (Docket No. 10,797) affecting the 890-940 mc. band and the so-called microwave mobile bands—3500-3700, 6425-6575, and 11,700-12,200 mc. The common carriers commenting in this case seek the whole 890-940 mc. band for their own fixed use, and the 6425-6575 mc. band for their fixed and mobile use. They recommend that for the present the other bands in issue in this proceeding be left in their existing undivided status. Noncommon carrier interests commenting are unanimous in urging that the whole proposal is premature and that decision upon it should be postponed pending the design and regularization of technical standards for microwaves. These happenings offer further evidence of the way people are thinking and of the tendency of the forces involved to diverge according to the nature of their interests. The common carriers, in their unified position, evidently are ready to exploit at least some of these bands, whereas the other groups concerned apparently do not expect to be in such a position until the microwave work in progress is completed.

"I should also refer briefly to the petition of the State of California (Docket No. 10,777) which has, I think, some bearing on this discussion. That petition seeks to use microwave facilities for state communications activities under regulations which would permit
(Continued on page 36)

INSTRUMENT METHODS IN AERIAL SURVEY

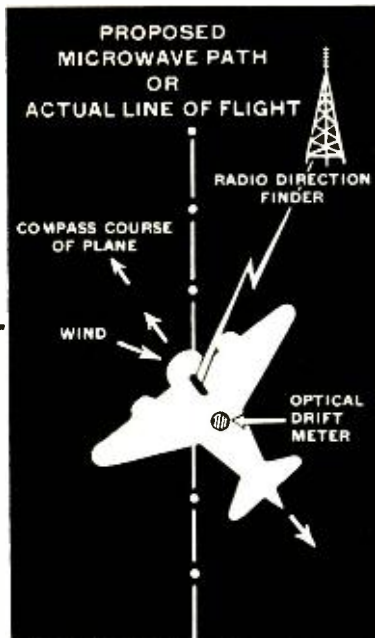

Radio bearings with correction for drift give correct line of flight during aerial microwave surveying.

By

MARC SHELDON
Microwave Services, Inc.

and

L. A. DICKERSON
Lockwood, Kessler & Bartlett, Inc.

Microwave surveys are simplified by using airborne radar, helicopter, and photogrammetry techniques.

APLICATION of aerial methods to microwave survey work is still in the early stages of development. The increasing popularity of their use would seem to indicate a need for detailed information on what the various methods have to offer, the factors to be considered in determining which method to use in preference to or in conjunction with other methods, and the results to be expected.

Visual and photographic aerial reconnaissance methods for locating stations in a microwave relay system have been discussed. Additional instrument methods include radar profiling, path testing using helicopters, and photogrammetric survey. This article will deal principally with the use of radar.

Radar Profiling

The basis of this method is the use of radar equipment installed in an airplane to measure the distance from the plane to the ground (or intervening objects, such as buildings). Since the measured ground elevations must be made independent of the altitude of the plane (which does not remain constant in flight), each reading of a radar altimeter must be correlated with a simultaneous reading of a barometric altimeter, which is itself referenced to a known elevation. Radar profiling must be preceded by some general knowledge of the area, either from existing mapping or from reconnaissance data; this knowledge is required in order to select a few tentative paths to be profiled.

If there is usable (but not necessarily precise) topographical mapping in the

area, the preparatory work in laying out the paths to be flown may be based on these maps, used in conjunction with whatever planimetric mapping and other data may be available. For example, the topographical mapping in certain parts of this country dates from 1890 or earlier, and is not sufficiently accurate in either elevation or position data to be relied on for final work. However, it generally gives enough information to indicate which are the

probable optimum paths that should be checked by radar profiling. When the road and other information from more recent planimetric maps (of the so-called "county map" type) is added, and possibly other data from sources such as power line construction maps, the selection of a relatively few likely paths can often be readily accomplished.

In an area where there is no usable topographic mapping, a photo-reconnaissance would probably be made as

Interior view of a cockpit, with inset showing arrangement of instruments.

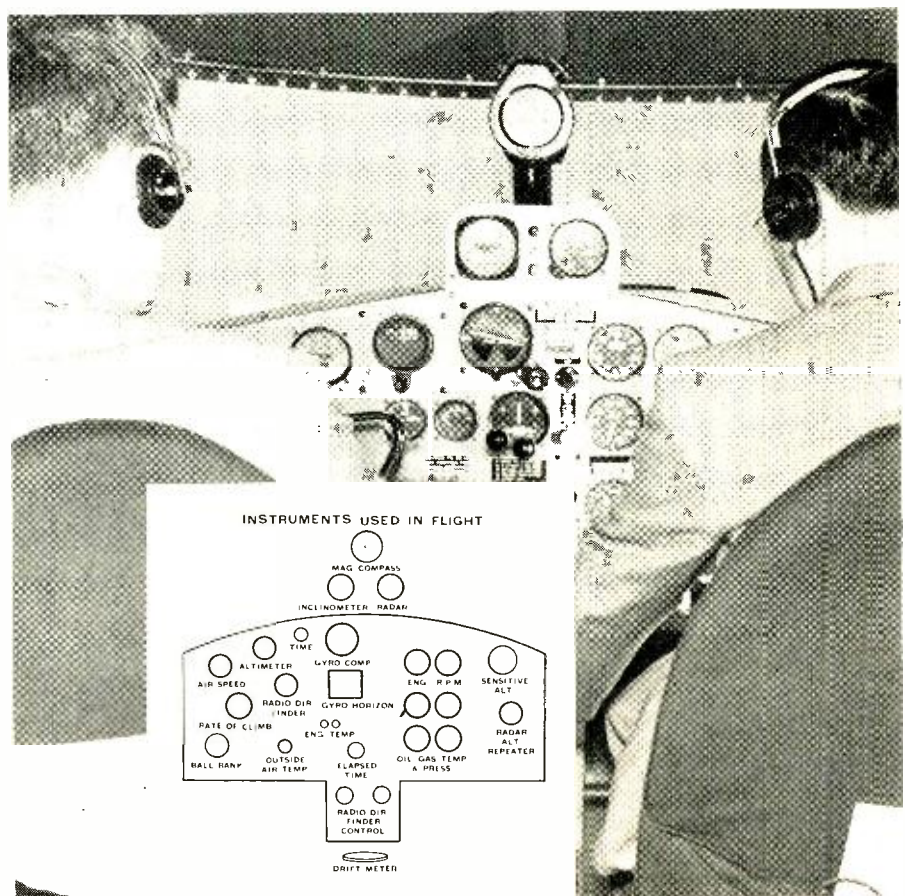

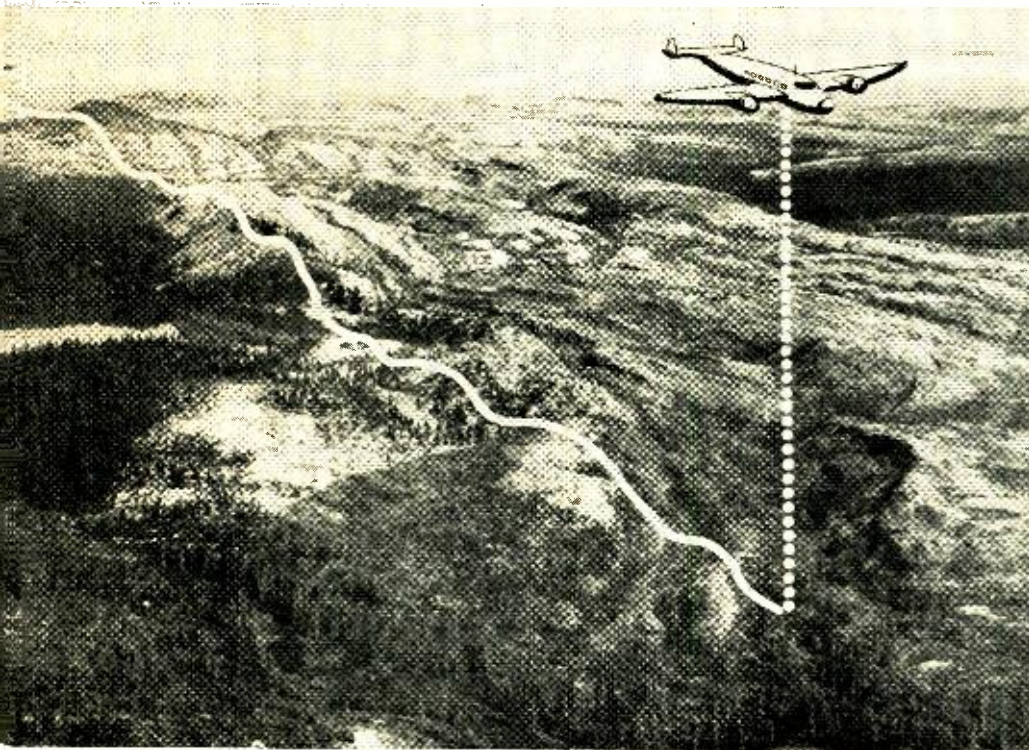

Schematic representation of the technique of radar profiling.

a first step. In some cases, it is possible that a visual reconnaissance alone might be adequate. From the photographs, together with all descriptive data on the area which can be assembled, much information on elevations, roads and other factors of interest can be obtained. From such information, the likely paths can be laid out. As many checkpoints as possible are identified for the pilot's use in keeping on the path during the profiling run.

Ground elevations of the terminal points of flight runs must be obtained to a good degree of accuracy, since other points on the path are referenced to them. This may be done by ground methods (altimetry or leveling from the nearest control elevation), or by radar profiling from the nearest control point. Stereo methods applied to reconnaissance photographs in certain cases may give the required elevation with reference to a known point with sufficient accuracy, provided the distance between the points is not too great.

To do radar profiling work, an airplane must be specially equipped for the job, a rather expensive process. For example, a typical installation might include two precision radar sets, two sensitive no-lag type barometric altimeters, synchronizing and recording equipment (photographic, tape, etc.) to make simultaneous records of all instruments, a counter, and a magnetic tape for recording flight commentary time-correlated with the other information. One or more aerial cameras are also generally carried.

At the present time, there are not many planes so equipped; as the demand increases, others will be prepared. The problem of obtaining sufficient technically trained personnel willing to fly at low altitudes is a difficult one but is not expected to limit the availability of radar profiling for microwave purposes.

In most radar profiling procedures, the information obtained must be correlated and adjusted after the flight is completed in order to obtain the final profiles.

The techniques of radar profiling may arbitrarily be divided into high-altitude and low-altitude methods. The latter is currently being used for a good deal of microwave survey work, with generally satisfactory results.

Low-Altitude Profiling

In low-altitude radar profiling, the actual profiling run is usually preceded by a higher-altitude reconnaissance flight (above 1000 feet) to spot possible sites and plot tentative flight lines, and also to observe checkpoints (such as road intersections) on the line. This flight is followed by the low-level profiling runs, at altitudes of 50 to 400 feet. During this flight the pilot flies as straight a course as possible from checkpoint to checkpoint as previously established. Where these are too widely separated, the crew may drop flour bags or other identifying marks along the flight path, to attempt to establish repeatability of course on return runs. Results on any path are generally not

accepted by the crew until they have been duplicated by at least one corroborating profile on a subsequent run.

The radar altimeters usually operate at a fairly high frequency and use directive reflectors in order to minimize beamwidth. One altimeter³, for example, operates on a wavelength of 3.2 cm., and uses a 4' parabolic reflector to achieve a 1.5° beamwidth. This particular unit has a crystal oscillator (for stability) as the heart of the timing circuit to control the firing of the transmitter and initiate the timing cycle. A pair of movable gate pulses straddles the video or echo pulse in a symmetrical fashion. If the gate pulses are forced to move to maintain symmetry, their motion controls the charge on the grid of a tube in whose plate circuit the coil of the recording meter is located. The change in charge on the grid controls the plate current, which is then recorded by the meter. Automatic sweep and automatic tracking circuits enable the gate pulses to search for and lock symmetrically over the video.

Calibration of the altimeters is generally accomplished in the following way. After the radar altimeters have been warmed up, they are calibrated in the air, using a standard delay line. Then, a level flight pass is made over a flat area of known elevation, such as a lake, and the pressure altimeters are set to read correct elevation of the airplane above sea level or other reference, based on the readings of the radar altimeters and the known elevation. The instruments may then be checked by flights at different altitudes over the known elevation.

Some of the radar profiling systems (like the one described above) provide substantially continuous recording of ground elevations. Others obtain discrete readings at sufficiently frequent intervals to provide a satisfactory profile, e.g., the technique of photographing the altimeters and other instruments at one-second intervals. Although this represents distances between readings of the order of 150 feet (at 100 miles per hour), any unusual elevation changes between readings would be noted in the flight commentary for subsequent checking. In addition, the return profiling run may provide a partial check if the second set of readings is out of phase with the first set.

The low-altitude radar profiling method can usually provide the profile information needed for microwave paths with sufficient accuracy, provided certain precautions are taken. These include repeating the profile run in the return direction to obtain confirmatory data, allowing for possible changes in barometric conditions during measurement runs, and checking doubtful elevations (such as ridge lines rising rapidly

above average terrain) by ground survey or other means. Foliage must be taken into account, since the radar may penetrate it either completely or partially.

High-Altitude Profiling

Another way of utilizing a radar altimeter for profiling is to take the readings from an altitude of the order of 5000 feet. This procedure has been used mainly for providing sufficient vertical control data for use in conjunction with the photogrammetric method, and has not been used to any extent for microwave applications.

Although the elevation errors average less than 20 feet, random errors in rugged terrain may exceed 100 feet. An even more serious difficulty from the microwave standpoint is that the plane cannot fly a straight line within acceptable limits, and therefore the profile obtained does not represent the microwave path desired.

These difficulties do not detract from the use of high-altitude profiling in its current major application, providing vertical control for use with photogrammetry, since only selected points on the profile—generally of smooth surface—are used, and these points are correlated with the plane's position at the time by photography. Whether the selected points are on a straight line or not is of no importance to the photogrammetrist, as long as they can be located with respect to horizontal control data.

One problem experienced by those using high-altitude profiling may be of interest for the light that it throws on the use of the pressure altimeter. Although the radar altimeter readings are corrected with respect to the barometric altimeter as the plane varies in altitude, the barometric altimeter itself is subject to a peculiarity of the atmosphere. "If there is no movement of the air mass, the plane can fly a level course by maintaining a constant reading on a sensitive altimeter. If there is movement of the air mass, to fly such a level course—or to reduce the results of maintaining a constant pressure altitude to such datum—requires a pressure correction somewhat similar to correction for tide. As the profile lines are flown, a record of the amount of 'crab' necessary to keep the plane on its designated course is kept, and from this a correction is worked out for the resulting rise or fall of the plane due to keeping to an 'equal pressure' altitude".

Accuracies

Accuracies in profiles obtained by radar profiling are limited by the skill of the crew in making and interpreting measurements, difficulties in flying over



Airborne helicopter for use in aerial surveys. Note receiving parabola.

certain types of terrain, dependence on precise barometric information, and problems in flying a straight line due to mapping deficiencies and other factors.

Independent tests⁴ conducted to determine the suitability and accuracy of one radar profiling method yielded the following information:

The accuracy of determining the elevation data at the point measured is usually within ± 20 feet, with maximum deviations per path generally not exceeding 60 feet. (When this method was first used, one source of error was the lag in barometric altimeter readings when the airplane changed altitude rapidly. This lag has been fairly well overcome by use of a sensitive aneroid altimeter which provides a current or voltage to operate a recording meter without mechanical loading on the aneroid). It should be noted that the pertinent elevations on the profile are usually the possible obstruction points, which are ordinarily few. Therefore, even rather large errors in the recorded elevations of lower points may be of no important consequence in evaluating the path for microwave purposes.

The precise determination of the positions of terrain features is a more difficult matter for several reasons. The planimetric mapping available in many areas is not particularly reliable (so-called county maps, for example, often contain $\frac{1}{4}$ - to $\frac{1}{2}$ -mile position errors)

and therefore may not be very satisfactory for establishing the flight line. Another possible source of positional error is the difficulty of flying an airplane along a straight line, although with sufficient checkpoints and a competent pilot such errors may be kept within tolerable limits, provided that the terrain features do not exhibit rapidly changing elevations across the flight line. Variations in airplane speed may have the effect of apparently displacing terrain features along the line of flight, but from a practical point of view this is generally not important since the amount of displacement is not great as compared to the half-path length, the criterion in determining Fresnel zone clearances.

Advantages

Radar profiling offers the advantages of all aerial methods over ground methods, namely speed and suitability for terrain where access by foot or vehicle is difficult. In comparison with other aerial methods, it offers one of the lower cost ways of obtaining profile data for microwave paths, provided that the number of possible route choices can be sufficiently narrowed by other means. A rough cost estimate of profiling by this technique is of the order of \$20 per final path mile, allowing for a maximum average of three separate routes per path to be profiled. Where more or fewer routes per path need to be flown, the cost will vary accordingly.

Weather conditions are of importance in the use of this method, apart from weather which would prevent flying altogether. Although the radar signal itself is relatively unaffected by atmospheric conditions, the barometric altimeter to which all readings must be finally referenced may be very much affected. During a period of unstable barometric conditions, it may be necessary to wait until the disturbances have passed before attempting to proceed with profiling.

This is a rapid method of obtaining data which is available in usable form within a relatively short time after the

(Continued on page 28)

Survey plane equipped with altimeter antennas (in circles).

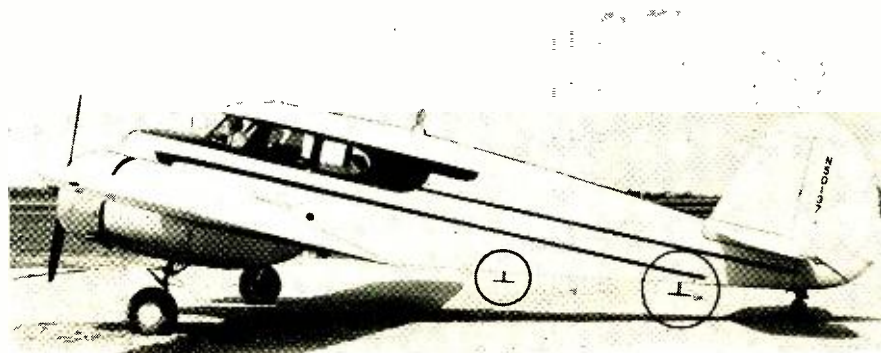

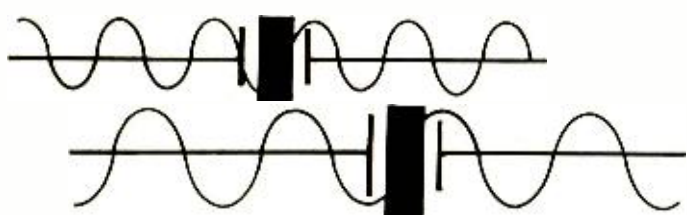

AUDIO AND R.F.

SECONDARY FREQUENCY STANDARD

By **ROBERT C. MOSES**

Lear. Inc.

Multiples and submultiples of a stable 100-kc. crystal-controlled oscillator provide accurate frequencies over a range of 1 kc. to 150 mc.

ACCURACY of frequency-measuring equipment which involves interpolation by subdivision of standardized r.f. frequencies depends upon the stability of the count-down circuits used to perform the subdivision. Multivibrators and blocking oscillators, because of their distinctly non-sinusoidal output waveforms and ease of synchronization, have found wide application in such count-down circuits. Relaxation oscillators are, however, inherently unstable with variations in operating voltages, tube parameters, and component values, with the result that frequent re-adjustment may be required in order to insure maximum over-all accuracy of the system. The secondary frequency standard to be described here is designed around a somewhat unique form of stabilized frequency-divider which is capable of precise counting ratios of greater than 100 at a phase stability of better than 30° , with line voltage variations of 80 to 130 volts and tube characteristic variations of $\pm 25\%$.

Utilizing cascaded decade-scaling circuits, this secondary frequency standard provides individual sine-wave and square-wave outputs at five discrete fundamental frequencies between 100 kc. and 1000 cps from a basic 100-kc. crystal-controlled oscillator. Because the submultiple frequencies are synchronized to the 100-kc. standard frequency, they have the same high order of stability as the latter, and are related to it by specific ratios of 2, 10, 20 and 100. In addition, supplementary standard frequencies of 1000 kc. and 10,000 kc. are provided by independent crystal-stabilized oscillators; these frequencies serve as markers to assist in

identification of the high-order harmonics of the basic 100-kc. oscillator and associated frequency divider. Appropriate pulse-shaping and amplification provides usable harmonics up through 150 mc., thus making standard frequencies available in the audio, video, and r.f. ranges.

Circuit Description

A functional block diagram of the secondary frequency standard is shown in Fig. 1. The basic 100-kc. standard frequency is generated in a pentode crystal oscillator, V_1 , of the modified Pierce type. In order to minimize frequency variations with changes in ambient temperature, the crystal is equipped with an integral constant-temperature oven operated at 30°C . The pentode electron-coupled circuit configuration provides excellent stability by virtue of load isolation, and permits the basic frequency-determining elements to be operated at very low power levels. A small portion of the output of the master oscillator is applied as synchronizing voltage to the two-stage frequency divider or counter chain, V_2 and V_3 . Specific details of the counter circuits will be discussed in a succeeding section. A second output from the master oscillator, after suitable wave-shaping, is mixed with the output of the frequency divider in order to enhance the higher order harmonics of the 100-kc. signal.

Supplementary 1000-kc. and 10,000-kc. marker frequencies are generated in two independent crystal-controlled oscillators, V_{5A} and V_{5B} . Because an ultimate degree of frequency stability is of secondary consideration in the marker circuits, triode oscillators are used, and the crystals themselves are not temperature-stabilized. Each crystal, however, is provided with means of adjusting its frequency to exact zero-beat with the appropriate harmonic of the 100-kc. master oscillator, and operation with light loading and at low power level tends to minimize long-time frequency variations. A fraction of the output of the 1000-kc. and 10,000-kc. oscillators is mixed with the 100-kc. signal and square-wave output of the counter chain to form a composite driving signal for the harmonic amplifier V_4 .

The harmonic amplifier utilizes a high-transconductance power pentode, type 6CL6, operated with zero grid bias and

Control panel view of the rack-mounted standard.

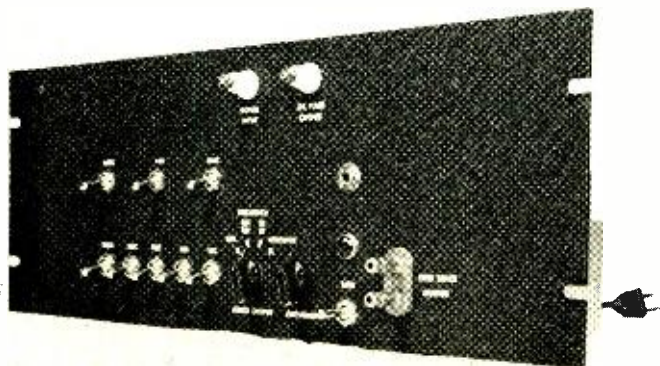

Top view of the chassis, showing parts placement.



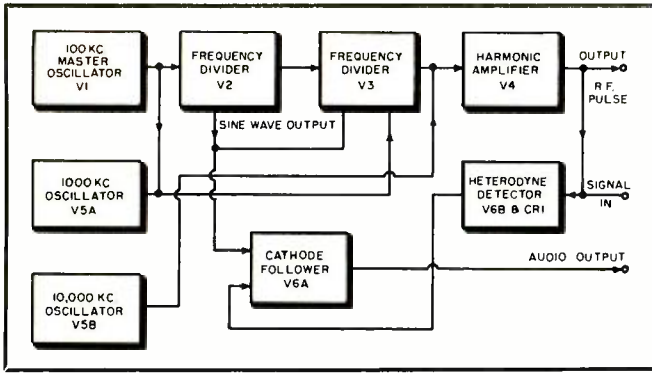

Fig. 1. Block diagram of the complete unit.

reduced screen voltage to provide pulse limiting and sharpening. Of the "high-peaker" type, the plate circuit contains broadly resonant elements in a stagger-tuned arrangement. Stagger frequencies are logarithmically distributed through the 5.0 to 50 mc. range, and a degree of underdamping is deliberately introduced. The resulting amplitude-frequency characteristic exhibits a rising response which compensates to an extent for the unavoidable falling-off in higher-order harmonic content of the composite signal. In the time domain, underdamping provides a substantial decrease in pulse rise time and introduces overshoots of fairly high amplitude at the leading and trailing edges of the pulse. Such a waveform may contain appreciable energy at frequencies many times that represented by the reciprocal of the pulse width. Further pulse-shaping is accomplished by means of appropriately short time constants in the harmonic amplifier grid circuit.

Sine-wave outputs at 100, 50, 10, 5, and 1 kc. are derived from appropriate points in the divider chain, and after suitable filtering are applied to a cathode-follower, V_{6A} , through a switching system. Standardized frequencies throughout the audio range are thus made available independent of the r.f. pulse output, adding to the flexibility and general usefulness of the instrument. An additional switch position provides audio output from a built-in heterodyne detector, V_{6B} and CR_1 , the input to which is mixed with the harmonic amplifier output through a capacitive network. Hence, an unknown frequency may be fed into the heterodyne detector and compared with a standard frequency by zero-beat techniques.

Counter Circuits

Because the design of the counter chain is perhaps the most unique feature of the frequency standard, a discussion and brief analysis of the circuits employed may be in order. The design objective lay in achieving maximum frequency and phase stability consistent with adequate high-order harmonic output to satisfy the requirements of the application.

The schematic diagram of Fig. 2 shows in simplified form one stage of the counter chain. This stage resembles an astable cathode-coupled multivibrator in which two cross-couplings between triodes V_1 and V_2 are provided. One of these is the a.c. path through C_1 from the plate of V_1 to the grid of V_2 , while the other is by way of the cathode impedance R_3 common to both tubes. Two important differences from the usual multivibrator configurations may be observed, however. First, the plate load of V_2 has been omitted and the plate grounded for a.c. Second, a parallel-tuned circuit, L_1-C_2 , has been included in the grid circuit of V_2 , and the value of the grid resistor R_1 made very much smaller than normal for the operating frequency involved. By the same token, the coupling capacitor C_1 is relatively large. It does not follow, however, that the grid time con-

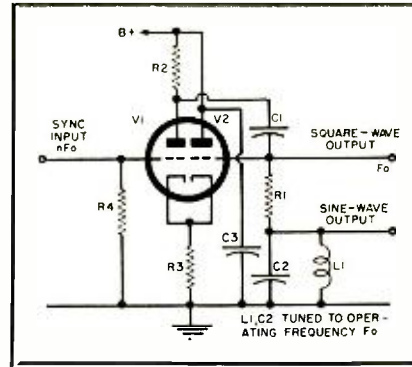

Fig. 2. Simplified diagram of one stage of the counter chain used to subdivide the frequency. Two such counters are used in this device.

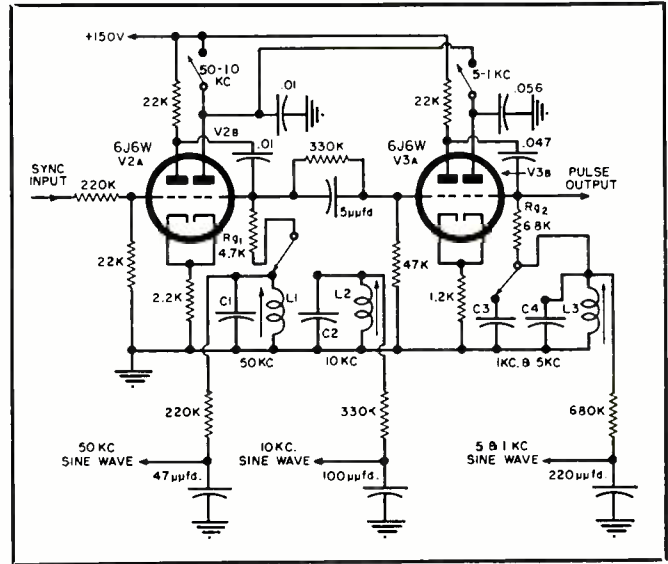

Fig. 3. A practical two-stage frequency divider.

stant C_1-R_1 would necessarily be the same for a given frequency as in the conventional multivibrator, since—as it will be shown—the frequency of operation is relatively unaffected by the RC product of the coupling network.

Conditions for oscillation in a cathode- or plate-coupled multivibrator may be expressed by:

$$G_1 G_2 \geq 1.0 \quad (1A)$$

$$\theta_1 + \theta_2 = 0 \text{ or } 360^\circ \quad (1B)$$

where G_1 and G_2 are the voltage gains of V_1 and V_2 , and θ_1 and θ_2 are the corresponding phase shifts in each stage.

In the circuit of Fig. 2, V_1 is equivalent to a grounded-grid amplifier and V_2 to a cathode-follower—as far as the feedback loop is concerned. Substituting the appropriate gain expressions, Eq. (1A) may be expanded to give:

$$\frac{\mu_2 (1 + \mu_1) Z_1 R_k}{(R'_{p1} + Z_1) (R'_{p2} + R_1)} \geq 1.0 \quad (2)$$

where μ_1 and μ_2 are the amplification factors of V_1 and V_2 , Z_1 is the effective load impedance of V_1 , R_k is the common cathode impedance, numerically equal to the input impedance of V_2 in parallel with the cathode resistor, and R'_{p1} and R'_{p2} are the effective plate resistances of V_1 and V_2 .

Effective plate resistances R'_{p1} and R'_{p2} may be determined to a close approximation by integrating the tube transconductance characteristics with respect to dE_p over the range from zero bias to cutoff. The result, expressed as an average plate current over a semiperiod of the square wave, is then multiplied by the duty cycle. Effective plate resistances R'_{p1} and R'_{p2} integrated over many pulse periods may then be evaluated by comparing the average plate current with the steady-state plate current under class A conditions.





for **TRUE**

HERMETIC

SEALING

Canseals by cannon

Hermetically-sealed multi-contact Canseal connectors made by Cannon are really rugged! And . . . they are the only connectors that give you true hermetic sealing under adverse pressure and atmospheric changes. Here's why . . .

Cannon pioneered the first successful hermetically-sealed connector more than six years ago . . . since then has continuously refined and increased the line. All have special steel contacts. Glass insulation . . . fused to both contacts and shell for a perfect permanent seal . . . is stronger than steel, withstands temperatures to 1000° F, and permits the use of the highest conductive steel contacts compatible with any glass fusing operation.

Available in a wide variety of insert layouts for control, relay, power, and instrument applications in Series GS (AN type), KH, RKH, U, DAH, BFH, TBFH, DBH, DCH, KH30 standard, miniature and sub-miniature sizes. Also, special mounting flanges and brazing service to help you obtain a strong and leakproof overall assembly.

**CANNON
PLUGS**



DH SERIES



U SERIES



KH SERIES



first in connectors

Please refer to Dept. 401

CANNON ELECTRIC COMPANY, 3209 Humboldt Street, Los Angeles 31, California
Factories in Los Angeles; East Haven; Toronto, Canada; London, England.
Representatives and distributors in all principal cities are at your service.

CINCINNATI TV CONFERENCE

Technical session highlights of Spring Television Conference held in Cincinnati on April 24, 1954.

EVERY spring, in the latter part of April, a group of television engineers assembles at Cincinnati, Ohio, to talk over various TV problems and to listen to technical talks given by engineers who are experts in their fields. This assembly, sponsored by the Cincinnati Section of the IRE and the IRE Professional Group on Broadcast and Television Receivers, is now known as the Spring Television Conference. Its importance stems from the fact that it is the largest conference in the country devoted exclusively to a discussion of television problems.

It would be impossible to cover completely all the important information presented at the 1954 Conference in this brief report. However, a few of the highlights have been sketched below, with the thought that they might be of interest to those who were unable to attend.

UHF TUNER DESIGN FOR THE 6BA4, Ralph S. Brown, Sylvania Electric Products Inc.

The new 6BA4 rocket tube is a disc seal planar triode designed for grounded grid operation. It has an amplification factor of 70 at low frequencies, a transconductance of 8000 micromhos, an input capacitance of 1.5 μf d., and an output capacitance of 1.0 μf d.

Figure 1 shows how the gain and noise figure vary over the u.h.f. band when the tube is used in a grounded-grid coaxial amplifier circuit. It is apparent that a gain of about 14 db with a maximum noise figure of 9 db can be achieved. In the v.h.f. band, tests reveal a noise figure of 4 db at Channel 2 and

Fig. 1. Measured performance of the 6BA4 in a grounded-grid amplifier.

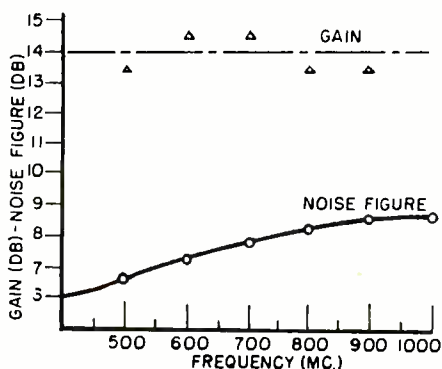

6 db at Channel 6, with a gain slightly exceeding that at u.h.f. These results indicate that the 6BA4 may make possible the realization of the ultimate goal for TV front ends, namely, a very high performance u.h.f.-v.h.f. tuner.

THE DESIGN OF I.F. AMPLIFIERS FOR COLOR TELEVISION RECEIVERS, by J. Avins, Radio Corporation of America

Mr. Avins evaluated the new problems introduced by the addition of the chrominance subcarrier and its sidebands with respect to i.f. amplifier design. The principal problem is that of providing adequate rejection at 41.25

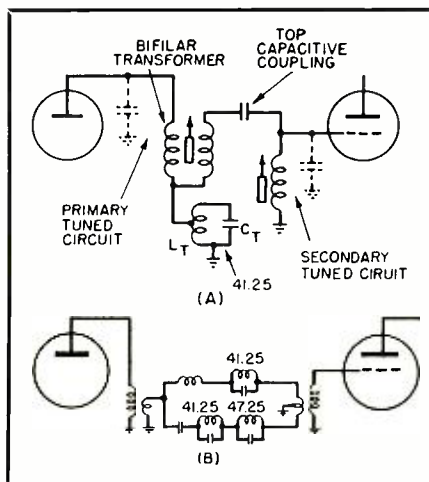

Fig. 2. (A) Double-tuned bifilar-T trap. (B) Stagger-tuned bridge trap which provides wide rejection notch at 41.25 mc.

mc. without introducing excessive delay in the color sideband region, which is separated from the sound carrier by less than 1% of the signal frequency. Novel nonminimum phase-shift trap circuits were described which provide the required attenuation with low delay distortion. These are in the form of stagger-tuned bridge and bifilar-T traps and combinations thereof. A stagger-tuned bridge is shown in Fig. 2B and a double-tuned bifilar-T in Fig. 2A.

THE MEASUREMENT OF YOKE ASTIGMATISM, R. A. Bloomsburgh, Philco Corporation

Astigmatism, the principal deflection yoke aberration, sets a fundamental limit on the performance of cathode-ray

tube displays and is possessed by all yokes in varying type and degree. Mr. Bloomsburgh analyzed the structure of an astigmatic beam with a view to measuring its properties objectively. He outlined two methods of achieving a numerical rating based on optical concepts, and discussed how microscopic measurements of the variation of the spot shape along the beam path give quantitative data regarding the primary and secondary foci. These data provide a basis for isolating the "optical" characteristics of deflection yokes. Further discussion disclosed methods of classifying and evaluating astigmatic errors in both monochrome and color displays.

TELEVISION TRANSMISSION FACTORS, J. M. Barstow, Bell Telephone Laboratories

The amount of distortion that can be tolerated in a TV transmission system is based not on physical measurements alone, but on judgment tests by critical observers. A group of such observers was asked to assist in determining how much amplitude distortion, delay distortion, and interference could be tolerated, and how much the bandwidth could be degraded for monochrome pictures. For color pictures, different factors were used in evaluating noise, and a change was made in the study of effects of amplitude distortion in the region of the subcarrier frequency. An additional factor of importance in color TV is differential phase.

THE CHROMACODER, James J. Reeves, Columbia Broadcasting System

This is a device permitting the use of a single-tube sequential color camera feeding into a "black box" or "Chromacoder." Here the signal is amplified and fed to the grids of three special picture tubes, which are gated on and off in such a manner that each of the tubes is sequentially turned on for the duration of a single color field. Facing each picture tube screen is an image orthicon whose function is to pick up only the one color displayed. By a combination of sequential scanning speeds, kinescope and image orthicon storage characteristics, three color signals are generated simultaneously. These signals are then encoded and transmitted as a normal NTSC signal.

One advantage of this system is that only a single Chromacoder is required. Any number of simple cameras or line
(Continued on page 38)

Why UHF stations prefer the **RCA** "1-KW"

- **UHF stations can get an RCA "1-KW"** when they want it (shipments are being made within 30 days after order).
- **RCA UHF engineering experience pays off for YOU.** WBRE-TV writes: "Not only are we getting the coverage where we wanted it—**WE ARE GETTING COVERAGE FAR BEYOND OUR ORIGINAL EXPECTATIONS!**"
- **RCA UHF spells Reliability and Simplified operation.** WTPA-TV says: "Our

TTU-1B operates as reliably as any AM transmitter. It's easy to maintain too—just a routine weekly maintenance and cleaning is all that's needed."

● **RCA can supply every UHF accessory you need.** WSBT-TV reports: "We like to get everything from one place, work with **ONE** responsible supplier—RCA."

Your RCA Broadcast Sales Representative is at your service for technical help. Let him get going on your UHF plans.



Exclusive features of the RCA "1-KW"

- * You can change power amplifier tubes in **LESS THAN A MINUTE**
- * The only 1-KW UHF with true centralized front panel control
- * High Level (PA) Modulation for superior linearity and flat response

30-DAY DELIVERY



RADIO CORPORATION of AMERICA
ENGINEERING PRODUCTS DEPARTMENT CAMDEN, N.J.

COMMUNICATION

REVIEW

MARINE RADIOTELEPHONE

Developed to withstand rugged usage in tugboats, fishing vessels, cabin cruisers and yachts, the *Allied Series 9000* line of compact marine radio-



telephones incorporates push-to-talk microphone switches and crystal-controlled receivers for positive operation. Receivers have a frequency range of 2-3 mc. and a sensitivity of 5 μ v.

Four different transmitters can be supplied, for six-channel or five-channel-and-broadcast operation. Input may be 6 or 12 volts, d.c., and output is either 7½ or 15 watts, depending on requirements. Accessory equipment available includes a noise limiter, remote station and marine antenna.

For additional information on the Series 9000 line, write to *Allied International Inc.*, 230 Park Ave., New York 17, N. Y. Ask for Bulletin #M.

MULTICHANNEL NETWORK

Load dispatching and interplant communications will be speeded up by the new five-station multichannel microwave network of the *Ohio Power Company*, an operating system of the *American Gas and Electric Company* with headquarters in Canton, Ohio. The equipment was supplied by *Motorola Communications and Electronics Inc.*, 4545 W. Augusta Blvd., Chicago, Ill.

At present, seven channels are in use with additional channels to be installed at a later date. The microwave network extends southward from Canton to the company's new Philo steam generating plant some 70 miles away.

FM RADIOTELEPHONE

The "Minipak" FM radio phone is a lightweight portable radio communication unit that can be used by personnel in remote areas. It is suitable for the needs of forestry men, survey crews,

contractors and engineers. Features include long battery life and extreme dependability in the face of hard usage.

Announced by *Radio Specialty Manufacturing Co.*, 2023 S.E. Sixth Ave., Portland 14, Oregon, the complete "Minipak" consists of an FM receiver, one or two single-frequency FM transmitters, a handset, antenna—dismountable whip, a battery pack and carrying strap. Power output is 1.2 watts, each transmitter, on 30-40 mc.; models for operation on frequency bands of 40-50 and 150-160 mc. are also available.

PESA-PIEA CONVENTION

Symposiums on microwaves and corrosion, ten major speeches, and 143 display booths were featured at the 26th Annual Convention of the Petroleum Electric Supply Association and the Petroleum Industry Electrical Association held in April at Dallas, Texas. Among the exhibits which demonstrated how the mating of the radio and oil industries has been brought about with a resulting gain for all concerned were walkie-talkie radios, two-way high frequency units for vehicles and offices, and ship-to-shore units to facilitate loading of tankers.

CARRIER TELEPHONE SYSTEM

A miniaturized carrier telephone system has been announced by the *Lenkurt Electric Company* which will multiplex



up to 48 telephone channels for transmission over suitable wide-band microwave equipment. Designated as Type

45BX, this system provides the largest number of channels economically available as a standard equipment arrangement at this time.

Using single-sideband, suppressed-carrier operation, the 45BX makes maximum use of the frequency spectrum with minimum loading of radio equipment. Equipment crosstalk, noise, and level stability are well within standards established for toll network links. Detailed engineering and application information is available on request from *Lenkurt Electric Co.*, San Carlos, Calif.

RAILROAD MICROWAVE CLINIC

Approximately 60 railroad communications engineers and officials attended a five-day clinic on microwave installation techniques which was held in the spring by the Engineering Products Division of *Radio Corporation of Amer-*



ica at Camden, N. J. Railroaders from all parts of the United States and Canada heard lectures by several of the many RCA specialists engaged in microwave equipment design and systems planning. Visits to two nearby microwave radio-relay stations and RCA's David Sarnoff Research Center in Princeton, N. J., were part of the training program.

MICROWAVE SYSTEM

Successful performance of a microwave communications system linking the principal operating points of the *Public Service Company of Indiana, Inc.*, was described at a carrier current session of the Summer and Pacific General Meeting of the American Institute of Electrical Engineers. It was recently installed as the result of the growth of the company which made a previous power line carrier system impractical.

The over-all system now consists of pulse-time division microwave between main generating and operating stations, and power line carrier linking remote stations with the microwave system. In addition to providing a reliable means of communication between points on the company's lines, the microwave system also provides for telemetering

on interconnects with outside power systems.

MOBILE TICKET OFFICE

Pye Limited, Cambridge, England, is supplying radio for the first radio-equipped ticket office in the world—a



mobile van, belonging to Keith Prowse, which will provide people within the Greater London area who wish to go to football matches, race meetings or garden parties, with an opportunity to book their seats on the spot. The van is to be in constant communication with a control room which acts as a central clearing office for ticket agencies.

LOW-BAND TWO-WAY RADIO

Addition of a 15-watt mobile unit to the *G-E* line of 25-50 mc. two-way radio communication equipment has been announced by the *General Electric Company*, Syracuse, N. Y. It is available in two models: MC 2-N for narrow-



band operation, and MC 2-W for wide-band operation. The power supply chassis is a dual interrupter type vibrator which makes possible the use of either a 6- or a 12-volt d.c. source interchangeably.

Transmitter, receiver, and power supply chassis are conveniently mounted within a small, louverless, completely enclosed housing featuring a removable cover and side panels for ease of inspection and maintenance. To avoid outside interference, the transmitter employs double-tuned circuits which attenuate spurious radiation in excess of minimum FCC requirements.



By the Push of a Button!

...in just 0.8 seconds your contact is made...

...WHEN YOU ADD HAMMARLUND Selective Calling Equipment to Mobile 2-Way Radio Systems

...AND it means

PRIVACY...QUIETNESS...CONVENIENCE

Privacy, speed, quietness and convenience become an accepted part of day-in-day-out operations of 2-way radio systems used to control large fleets of emergency service or commercial vehicles, or distant fixed stations, when Hammarlund Selective Calling Equipment is added.

By the push of a button the dispatcher selects within 0.8 seconds the vehicle, remote station, or group of receivers which he wants to contact. Only the *selected* operator or group of operators can receive the call.

If a radio operator is away from

his station when a call comes in, an indicator light will be turned on to show he was called while absent. For police and other emergency vehicles the horn or other alarm can be remotely activated to summon drivers whose work has taken them from the immediate vicinity of their cars.

Write today to the Hammarlund Manufacturing Company for descriptive information about this selective calling equipment that was engineered to produce new benefits for you from your 2-way radio system. Ask for Bulletin R-6.



HAMMARLUND MANUFACTURING CO., INC.
460 WEST 34th ST. • NEW YORK 1, N. Y.

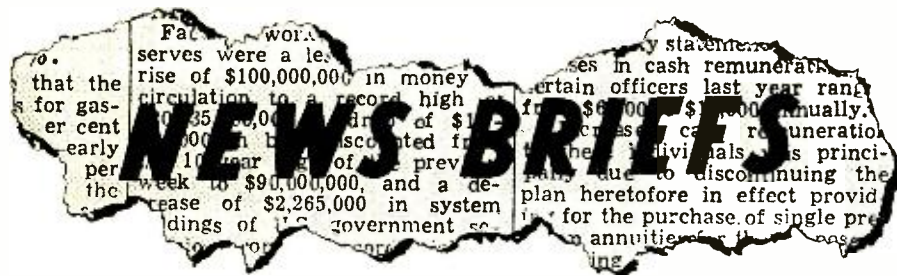

SILICON DIODE EVOLUTION

Shown in this photo-story prepared by *Texas Instruments Incorporated*, 6000 Lemmon Ave., Dallas 9, Texas,

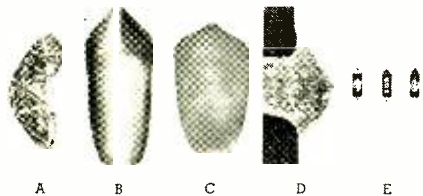

is the evolution of silicon diodes from the polycrystalline silicon (A) commonly used for point-contact diodes to actual production units (E) complete with glass-to-metal hermetic sealing. (B) is a newly developed grown single crystal of high purity silicon, (C) a sectioned single crystal showing homogeneous structure, and (D) a photomicrograph of the semiconductor alloyed junction of a new *T1* silicon diode.

ELECTRONIC SOUND TESTING

Electronic sound testing of ANGL-gears is the final step in a series of inspections carried out by *Airborne Accessories Corporation*, Hillside, N. J., to insure smooth-running gears with long life. ANGL-gears, the standardized right angle bevel gear units made by *Airborne*, are individually tested for quietness of operation with special equipment designed by *Airborne* engineers.

Noise level is the best indication of the condition of the gears, and of



whether or not they are in the best running position. Noisy gears mean unbalanced tooth load and eventual chip-

ping and shearing of gear teeth. This electronic testing equipment eliminates the chance of human error in judging the degree of quietness when gears are run at rated speed.

UNDERWATER TV CAMERA

When the English jet plane—the Comet—crashed in the Mediterranean Sea, a special underwater TV camera assembled by *Pye Limited*, Cambridge, England, was flown out to help search for it. Several portions of the Comet have been seen on the television screen, and photographs taken from the screen



have enabled experts to carry out examinations which otherwise could only be made with diving-bell equipment or by bringing the parts to the surface.

In the photograph, the *Pye* camera is shown aboard the I.M.S. "Wakeful." While the ship moves at up to four knots, the camera is trawled like a fishing net over the side. It has worked continually, even in very rough seas, and pictures of the sea bed 400 feet down have been reported to be as clear as would be expected in London on a dull day.

RADIOACTIVITY STANDARDS

Official custodian of the nation's first standard of radioactivity since 1926, the National Bureau of Standards is now engaged in an extensive program of research and development aimed at producing standards of radioactive nuclides. Some 55 samples of radioactive

nuclides are maintained and distributed along with more than 700 other basic standards for all fields of engineering and physical sciences.

Besides meeting domestic requirements, the Bureau is engaged in a



cooperative program with the National Physical Laboratory of the United Kingdom, the Canadian National Research Council, and Atomic Energy of Canada Limited. The chief aim of this program is to intercompare radioactive standards with a view to creating and improving international standards.

Radioactivity facilities at NBS are divided into six laboratories: the Gamma-Ray Laboratory, Radon Testing Laboratory, Alpha-Ray Measurements Laboratory, Radioisotope Standardization Laboratory, Nuclear Spectroscopy Laboratory, and Radio-Chemistry Laboratory. The photograph shows radioactivity standards which are available.

COMPUTER DESIGN REFINEMENT

Preliminary information has been released on the redesign of a new type of aircraft fire control computer which has resulted in weight reduction from 12½ to 3½ pounds, increase in number of computations performed, reduction in cost, and improved performance and reliability. Through the collaboration of *Servo-mechanisms, Inc.*, and *Electro-Mec Laboratory, Inc.*, a system of stand-

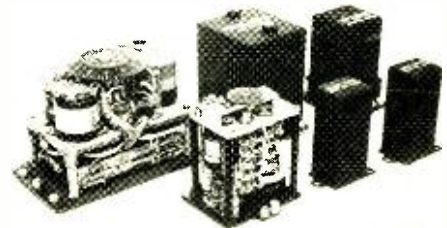

ardized "package servo components" (made by *Servo-mechanisms*) and "ultra" ultra-low-torque potentiometers (made by *Electro-Mec*) has provided an unusual example of miniaturization and design refinement.

The accompanying illustration shows a comparison of the original servo units in the background and the redesigned units in the foreground. Information on the ultra-low-torque potentiometers

can be obtained from *Electro-Mec Laboratory, Inc.*, 21-09 43rd Ave., Long Island City 1, N. Y.

ELECTRONIC CIRCUIT ELEMENT

At the 1954 Electronic Components Symposium in Washington, D. C., in May, Isaac L. Auerbach, manager of the Special Products Division of *Burroughs Corporation's* Research Center in Paoli, Pa., presented a paper entitled "The Potentialities of Bimags in Circuits of Information Processing Systems." The "bimag" (bistable magnetic core) is a new electronic circuit element for information processing systems which has brought about a substantial reduction in size and weight, as well as power, of many parts of such systems. The bistable characteristics of these magnetic cores have made possible a new class of circuitry.

TRANSFORMER TEST FACILITIES

Facilities for the development and testing of radar modulator components have been installed at *Moloney Electric Company*, 5590 Bircher Blvd., St. Louis 20, Mo., to supplement its specialty transformer test facilities. A pulse generator capable of producing 40-mega-watt peak powers at pulse durations ranging from 0.05 to 10 μ sec. or longer has been designed and built under the supervision of David F. Winter, electronic consultant; corresponding to the duty cycle specified, average power up to 40 kw. can be delivered to a specially designed adjustable resistance pulse load.

INDUSTRY TV PROGRAM

All set manufacturers have been requested by the Radio-Electronics-Television Manufacturers Association to cooperate in a voluntary program of self-regulation designed to minimize the interference of TV and FM radio receivers caused by radiation and spurious emissions. Dr. W. R. G. Baker, as chairman of a special committee on spurious radiation, proposed a detailed plan for industry-wide adherence to RETMA engineering standards, and warned that failure of manufacturers to adopt this plan would lead to regulatory action by the Federal Communications Commission in the public interest.

As submitted to the industry, the RETMA plan calls for adherence to the recommended intermediate frequency of 41.25 mc. for television receivers, proposed radiation limits for TV and FM sets, and voluntary submission of sets for testing and certification to an independent laboratory to be selected by the special committee.



look to

CHICAGO

for the "missing links" in

EXACT REPLACEMENT TRANSFORMERS FOR

LINK RADIO EQUIPMENT

For many years, CHICAGO has made most of the transformers and filter reactors for Link Radio equipment which is widely used in police communication and other mobile applications. CHICAGO Exact Replacement Transformers for this equipment are now available through your electronic parts distributor. The CHICAGO catalog numbers are identical to the Link parts numbers. See your distributor for these components.

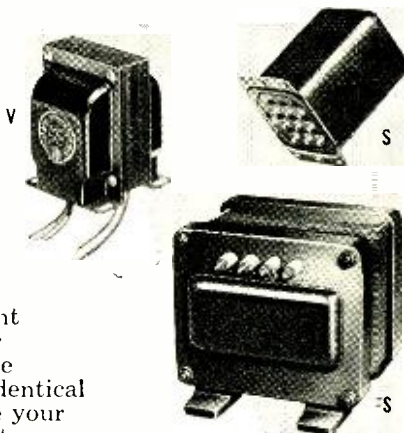

IN STOCK FOR IMMEDIATE DELIVERY

CHICAGO CAT. NO.	TYPE OF UNIT	REPLACES LINK RADIO PART NUMBERS:	MTG. TYPE	LIST PRICE
TR-1034	Vibrator Transformer (6 v.)	TR-1034 and 12534	V	\$ 9.50
TR-1035	Vibrator Transformer (12 v.)	TR-1035, 14269	V	9.50
TR-1040	Plate Transformer	TR-1040 and 11862	FS	97.50
TR-1050	Vibrator Transformer (6 v.)	TR-1050	V	9.90
TR-1054	Plate Transformer	TR-1054, 11944, 4891	V	18.50
TR-1056	Filter Choke	TR-1056, 0122U	V	10.85
TR-1063	Filament Transformer	TR-1063, 11992, 7211	V	10.50
TR-1065	Power Transformer	7650N, TR-1065	S	13.50
TR-1072	Power Transformer	TR-1072, 6248	V	9.50
TR-1073	Vibrator Transformer (6 v.)	TR-1073, 6250, TR-1080	V	9.25
TR-1077	Filter Choke	TR-1077, 7282N	BX	24.25
TR-1081	Output Transformer (Plate to Grid or Line)	TR-1081	S*	15.00
TR-1082	Filament Transformer	TR-1082	TX-1	31.25
TR-1083	Filament Transformer	TR-1083, 8218N	TX	20.50
TR-7074	Vibrator Transformer (12 v.)	TR-7074	V	11.50

*Pin-type terminals in place of solder lugs.



Free CHICAGO Complete Line Catalog

You'll want the full details on all CHICAGO Transformers— "Sealed-in-Steel" New Equipment Transformers, ML-T-27 Transformers, Television Replacement Transformers, General Replacement Transformers and Control and Power Circuit units. Write for your free copy today, or get it from your electronic parts distributor.



CHICAGO STANDARD TRANSFORMER CORP.

3501 W. ADDISON ST., CHICAGO 18, ILL.

EXPORT SALES:

Roburn Agencies, Inc.,
431 Greenwich Street,
New York 13, N. Y.

NEW TUBES

JUNCTION POWER DIODES

Seven junction power diode types have been added to the *Radio Receptor Co.* line: 1N91, 1N92 and 1N93 are of the type shown in the foreground of the photograph; 1N151, 1N152 and 1N153 are each a single diode mounted on a cooling fin; and 1N158, illustrated, consists of two diodes as indicated by arrows, connected in series and mounted on a cooling fin.

Small and hermetically sealed, these units have construction features which provide for long life and stable operation. Type 1N153 has a peak inverse

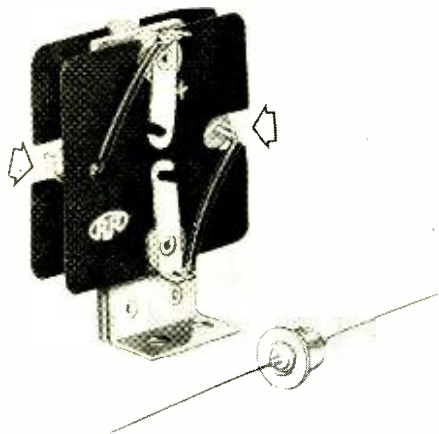

rating of 300 volts and is capable of delivering .5 ampere into a resistive load with a drop of only .7 volts. For further information on all seven diodes, including complete characteristics and curves, communicate with the Sales Department, Seletron & Germanium Division, *Radio Receptor Co., Inc.*, 251 West 19th St., New York 11, N. Y.

HEAT-RESISTANT ELECTRON TUBE

A rugged hard-glass electron tube designed to withstand the high thermal environment and extreme stress conditions in military and commercial aircraft has been developed by the Red Bank Division of *Bendix Aviation Corporation*, Eatontown, N. J. The first of its kind ever engineered for mass production, the 6AQ5 will help to break aviation's "internal heat barrier" created by high operational bulb temperatures and limiting space factors; it has an envelope of Nonex glass and will operate at a bulb temperature of 572° F for a minimum of 1000 hours.

Product of a four-year engineering program, the 6AQ5 resulted from a study of electrical and mechanical fac-

tors present in the severe environmental conditions in modern aircraft. It represents a major advancement in electronic tubes which is expected to help lengthen the life span of an ever-increasing number of automatic systems being installed to control many phases of flight at high speeds and altitudes.

IMPROVED LAWRENCE TUBE

Pilot production of an improved version of the Lawrence color TV tube has begun at the West Coast Development Laboratory of *Chromatic Television Laboratories, Inc.*, at Oakland, Calif. Known as the Chromatron PDF 21-3, it incorporates *Chromatic's* latest design developments including a radiation-suppressed Chromapac (the color grid structure at the front of the tube), and gives a true rectangular picture 14½" x 11".

Like other versions of the Lawrence tube, the new Chromatron is a single-gun, post-deflection focusing tube. Contained in a glass envelope, the PDF 21-3 is only 25" long. Its rectangular shape allows for a cabinet size 20% smaller than previous round metal tubes.

REGULATOR TUBE

Compact in design, the *Chatham* Type 6337 is a low- μ power triode for d.c. regulating circuits. It features high plate dissipation and high perveance, a

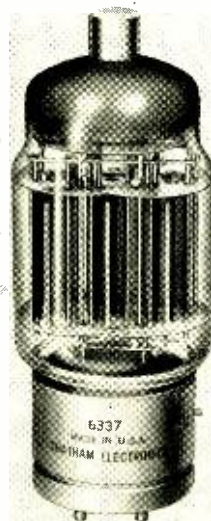

plate current held within $\pm 10\%$, and absence of plate current drift.

A hard glass envelope and a button stem that strengthens the mount provide

high immunity to extreme shock and vibration—Type 6337 is capable of withstanding 500G shock—and interlead spacing practically eliminates electrolysis. For complete information, write to *Chatham Electronics Corp.*, Livingston, N. J.

KU-BAND KLYSTRON

Varian Associates, Palo Alto, Calif., has announced a new Ku-band reflex klystron—a compact, rugged, low volt-

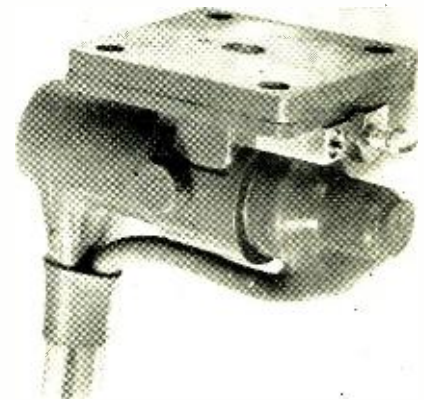

age local oscillator type tube for missile and radar applications in the frequency range of 16 to 17 kmc. At 300 volts beam potential, the VA-94 provides a minimum of 20-mw. power output and 55-mc. bandwidth, assuring ample performance in mixer and test set applications.

Features include the convenience of wave guide output, matched load operation, miniature size, minimum weight, and *Varian's* exclusive molded silicone rubber leads for high altitude and high temperature service. Microphonics are negligible, even under high amplitude 10G vibration or 150G impact conditions.

RCA COLOR TV TUBES

Designed for use in color TV broadcasting, the RCA-5AUP24 is a scanner-type cathode-ray tube, and the RCA-6474/1854 is a new image-orthicon type of camera pickup tube—the first to embody the supersensitivity required for color TV broadcasting. Both have now been made commercially available by the Tube Division of *Radio Corporation of America*, Harrison, N. J.

The scanner tube can be utilized as an integral part of various video signal generators which can pick up station call letters, test patterns, and other picture material. It is a color version of the original "flying spot" tube developed by *RCA* in 1948 for monochrome work.

Intended for color cameras which employ a simultaneous pickup system, the image orthicon can be used for both studio and outdoor telecasting. Three

tubes are required with each color TV camera—one for each of the primary colors. The 6474/1854 is incorporated in all RCA color cameras in use today.

CRYSTAL PHOTOCELL

Extreme sensitivity to light is featured in the Type CL-1 crystal photocell which has been developed by *Clairex Corporation*, 50 West 26th St., New York 10, N. Y. Employing a small cadmium sulphide crystal as the light-sensitive element, the *Clairex* photocell has a sensitivity to light flux of the order of one million times the sensitivity of a conventional high-vacuum photoemissive cell. The median sensitivity to light intensity is 100 μ amp. at 100 volts at 2 foot-candles.

In addition, Type CL-1 has a very high ratio of light-to-dark current for a photoconductor—of the order of 60 db at 1 foot-candle. At low light levels, the output is sufficient to fire a cold-cathode discharge tube and to operate directly meter or electrostatic relays. At high light levels, the output is sufficient to operate conventional sensitive magnetic relays directly.

TEMPERATURE-LIMITED DIODES

Addition of two new tubes to the "Kalotron" line of temperature-limited diodes has been announced by *Ther-*

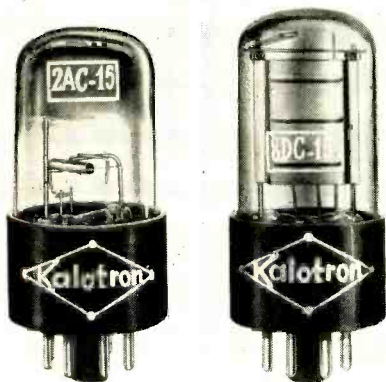

mosen, Inc. Designated as 2AC-15 and 8DC-15, both tubes use T951 bulbs and #8537 intermediate octal bases. The 2AC-15 incorporates a patented *Thermosen* feature by means of which filament failure causes an external high impedance circuit to be closed.

Electrical specifications for the 2AC-15 are: filament voltage, 1.8 d.c./a.c.; filament current, 310-335 ma.; plate voltage, 500; plate current, .410-.550 ma. Specifications for the 8DC-15 include: filament voltage, 5.6 a.c./d.c.; filament current 55-75 ma.; plate voltage, 500; and plate current, .450-.575 ma. Further information may be obtained by writing to *Thermosen, Inc.*, 361 West Main St., Stamford, Conn.

CORNELL-DUBILIER

and *Faradon*

The universally recognized standard in MICA transmitter capacitors.



Cornell-Dubilier Electric Corp., So. Plainfield, N. J.

There are more C-D capacitors in use today than any other make. See your classified telephone directory for name and address of nearest C-D authorized distributor.

CONSISTENTLY DEPENDABLE

CORNELL-DUBILIER CAPACITORS

PLANTS IN SO. PLAINFIELD, N. J. NEW BEDFORD, WORCESTER AND CAMBRIDGE, MASS.

PROVIDENCE, R. I. INDIANAPOLIS, IND. AFFORD AND FUGUAY SPRINGS, N. C. SUBSIDIARY: RADIART CORP. CLEVELAND, OHIO.

got enough EARS?
BE ON THE CONSTANT ALERT
All Departments Can Now Listen to Every Vital Message

- Nation's most complete line of monitor receivers.
- Crystal controlled or tunable for any VHF FM communication system.
- Mobile or stationary receivers.
- Prices to meet any budget.
- Certified for civil defense use.

MONITORADIO for a thoroughly coordinated 2-way communication system.
Now every member of every department can have radio communication for as little as \$49.95
Write today for further information.

MONITORADIO RADIO APPARATUS CORPORATION
55 North Jersey St., Indianapolis, Ind. Phone: ATLantic 1624

Transmission Levels

(Continued from page 11)

of the circuit between any two points.

Although level has definite value in circuit planning, it is necessary to consider actual power or power level involved when designing and operating the electronic equipment used at voice and carrier frequency terminals and repeaters. Operation of electronic equipment depends on the minimum and maximum power levels which can be supplied to the input of the equipment and delivered from the output. Equipment sensitivity and coincident power level of noise and other disturbances usually determine the lowest practical input power level. Maximum output power level (and consequently the maximum input) depends upon the power-handling capacity of the equipment.

Specifications for carrier equipment normally give the test tone power level at the inputs and outputs of each channel. In some cases, it is desirable or necessary to know the total peak power that may be delivered to common equipment or to the line by several channels. Per-channel power level is normally stated in dbm. Because dbm is a logarithmic value, two values expressed in dbm cannot be added to obtain the total. Instead, each channel power level must be converted to watts, added, and the total then reconverted to dbm. If

the per-channel power of all channels is the same, doubling the number of channels increases the total by 3 db. Thus, if a system has eight channels, each with a signal output power level of +10 dbm, the total delivered to the line is +19 dbm.

A typical carrier circuit arranged for radio transmission, with a four-wire termination at one drop and a two-wire hybrid termination at the other, is shown in Fig. 2. Typical test tone power levels at the connections to the carrier equipment are indicated.

Voice-Frequency Levels

The voice-frequency (v-f) level at the input to the transmitting branch of a carrier system is primarily based on the normal amounts of power delivered to the line from the toll switchboard. Because many telephone offices are arranged for patching circuits on a four-wire basis at a -16 level, and the usual test tone power at the transmitting toll test board is 0 dbm, the input stages of carrier systems are often adjusted to accept a test tone power of -16 dbm on a four-wire basis. This really means that the input to the carrier system is at a -16 level or at a circuit point 16 db removed from the two-wire v-f level at the transmitting toll test board.

The v-f level at the output of the receiving branch of a carrier system is also determined primarily by switch-

ing requirements. If all of the other values indicated in Fig. 2 are within proper limits, the v-f level for each channel would normally be about +7 db on a four-wire basis.

Instrument Methods

(Continued from page 15)

flights are completed, permitting prompt evaluation of the results so that additional paths may be profiled if required while the plane and crew are still in the area.

The radar profile method is particularly advantageous for use where reconnaissance has narrowed the choice of possible paths requiring measurement, and where accuracy of horizontal positioning of profiles is not too critical. Although no fixed dividing line can be set, radar profiling is likely to be economical up to the point of measuring three to four alternate routes per path. Beyond that it is likely to become too costly.

It should be noted that while the radar method is subject to weather delays, the weather factor is less critical than is the case in the photographic phase of the photogrammetric method, for example. In using the radar method, satisfactory weather conditions may be expected on the order of 50% of the time, while weather conditions suitable for photogrammetry may occur on the order of 10% of the time.

CATHODE EMISSION TRACER

THE CATHODE emission tracer developed by L. A. Marzetta of the National Bureau of Standards provides a rapid, convenient method for measuring and evaluating the performance of thermionic cathodes. It automatically produces a calibrated plot of the emission characteristics of the cathode of a diode on the screen of a cathode-ray oscilloscope. A "2/3-power network" is incorporated into the system and may be used at the option of the operator for linearizing the plot. Negligible heat is contributed to the diode under test since the tube is subjected to only a 10- or 100- μ sec. saw-tooth wave at rates of

either 5 or 30 cps. Provision is made for instantaneous plate currents as high as 10 amperes and for plate voltages up to 5000 volts, although these limiting values are not available simultaneously.

Two parallel-connected power triodes (type 304TH's) are connected in series with the test diode. The grids of these control triodes are raised from cutoff to zero bias with a saw-tooth signal, resulting in a saw-tooth wave through the test diode. This signal is also applied to the horizontal amplifier of the oscilloscope, and the voltage across the tube appears on the vertical amplifier. Composition of the signals produces the desired emission characteristic.

The saw-tooth voltage originates in a repetitive multivibrator or a single-shot multivibrator, depending on the time duration and rate desired. Output of the multivibrator is applied to a capacitor-charging circuit and generates the saw-tooth wave, which is amplified to a level that is sufficient to raise the grids of the 304TH's from cutoff to zero bias. A type 6V6 tube satisfies the driving requirements, since the grids are not driven into the positive grid current region.

This instrument also provides a round-dot calibration marker whose position can be manually controlled. Two meters on the instrument panel monitor the vertical and horizontal positions of the marker and indicate the diode voltage and current at any point on the trace representing the tube characteristic.

The cathode emission tracer in operation.



each providing slightly more than 180° of rotation. Choice of antenna depends on the direction of the wind at the time of operation.

The height of the helicopter at any time may be read on a survey-type portable altimeter. The altimeter is calibrated by setting it at zero with the helicopter on the ground. Thereafter, heights can be read directly to accuracies within five feet. Plumb lines may also be used for this purpose, as well as for determining tree heights.

Experiments have shown that the signal cutoff point is quite sharp as the beam falls below the grazing point. To take readings over any site takes only a few minutes.

The frequency used in making the tests need not be the frequency of the proposed link. In a particular case, a frequency of the order of 9000 mc. was used, because the equipment was smaller and lighter for the same antenna patterns, and was readily available. Adjustments for differences in Fresnel zone radii at different frequencies can readily be made.

A variation of this method is to use light sources in the helicopters. Heliostat-type equipment when there is sufficient sunlight, or very strong focused lights at twilight or at night, will provide information on the elevations required to achieve line of sight. Proper Fresnel zone clearance requirements can then be established based on this data.

Cost of a helicopter plus pilot varies considerably with the amount of utilization which can be scheduled, and may be expected to be between \$50 and \$100 per hour.

The helicopter method may be very advantageous in terrain which would be difficult to profile, for reasons such as heavy vegetation cover, few control points or checkpoints, and the like. In addition, in areas where possibility of interference with other systems exists, path testing provides a direct method of determining the amount and nature of the interference.

It is important to recognize one inherent pitfall in this method. Since microwave signals of all frequencies are subject to refraction, and since the index of refraction varies with atmospheric conditions, signal strength patterns recorded at one time will not necessarily represent the patterns to be expected at another time.

Photogrammetry

A method of microwave path determination which is particularly suitable for unmapped or poorly mapped areas is the photogrammetric survey method, the one by which most topographic mapping is performed today. It is based on the principle of taking photographic views of an object from two separated points. When these are viewed and used together stereoscopically, three-dimensional information is obtained. Unlike photographic reconnaissance, photogrammetry is a precision survey method in which unknown points are determined with reference to known control points, as in ground survey.

The actual survey takes place in the office, using specialized instruments, after the photography has been secured. Accuracies which can be achieved vary with the amount of ground control available, but are generally correct within 20 feet for elevations and within 75 feet for horizontal positions. Cost of the method depends on the strip width required, and the amount of information it is desired to obtain in the strip.

REFERENCES:

1. Sheldon, Marc, and Dickerson, L. A., "Aerial Reconnaissance for Microwave Surveys," RADIO-ELECTRONIC ENGINEERING, July, 1954, P. 7.
2. Photographic Survey Corp. Ltd., Toronto, Ontario, Canada.
3. Kelsh, Harry T., Report on Airborne Profile Recorder, Photogrammetric Engineering, March, 1952.
4. Conducted for RCA Victor Division, Radio Corporation of America, by Frank H. McIntosh, Washington, D. C.
5. McCaffrey, B. I., "Siting Microwave Antennas," PSC Applied Research, Toronto, Ontario, Canada.



Specifically Designed For
Rugged Mobile Communications Service

DEPENDABLE and Trouble-Free VIBRATORS



Select your replacement vibrators wisely... and you, too, will choose Radiart! Laboratory tests and customer reports prove that Radiart Vibrators give LONGER LIFE and trouble-free performance BECAUSE THEY ARE BUILT TO WITHSTAND RUGGED SERVICE! These extra hours of dependable performance is one of the factors that has made Radiart the leader. Superior engineering and design have made them THE STANDARD OF COMPARISON.

At all good radio parts jobbers. Ask for the new Form F781 listing the latest replacement recommendations.



IT'S RIGHT WHEN IT'S RADIART

THE RADIART CORPORATION

CLEVELAND 13, OHIO



- ROTORS
- VIBRATORS
- AUTO AERIALS
- TV ANTENNAS
- POWER SUPPLIES

TECHNICAL BOOKS

"APPLIED ELECTRONICS ANNUAL 1953-54" edited by R. E. Blaise, A.M., Brit. IRE. Published by *British-Continental Trade Press Ltd.*, London. Available in U. S. from J. D. Griffiths, 1502 Clegg St., Greensboro, N. C. 257 pages. \$5.00.

In the third edition of this international yearbook and directory, additions and improvements have been made to increase further the usefulness of the book as a source of reference to those wishing to be kept informed on the progress and acceptance of electronics in industry and research. This edition incorporates, for the first time, a chapter on new devices and components of general interest and a "Who's Who" for the electronics industry.

Developments in radio and television throughout the world are covered, and there are reports on the applications of electronic equipment in industries as diverse as textiles, fishing and printing. As in previous years, notes of current interest to those engaged in the export of electronic equipment are included. The world directory section classifies all manufacturers, suppliers, importers, and trade marks, and contains an enlarged, revised Buyers' Guide.

"ADVANCES IN ELECTRONICS" Volume V, edited by L. Marton, National Bureau of Standards. Published by *Academic Press Inc.*, 125 East 23rd St., New York 10, N. Y. 420 pages. \$9.50.

Volume V of "Advances in Electronics" is divided into eight sections, each contributed by an author experienced in the field. A new feature is presented in this volume: in addition to an index of authors and a subject index for Volume V, there are also cumulative author and subject indices of articles appearing in all of the five volumes of this series.

In the first section, the performance of detectors for visible and infrared radiation is discussed. This is followed by a treatment of beta-ray spectrometers as used in nuclear disintegration studies. The third section deals with solid-state luminescence, and the fourth with the use of thorium oxide in the field of practical electronics. Then, there is a review of modern vacuum pumps in electronics manufacturing, a treatise on the steady-state theory of the magnetron, a review of recent work in color television, and finally, a discussion of junction transistor applications.

Frequency Standard

(Continued from page 18)

tially square in the manner of a relaxation oscillator. By the same token, a small synchronizing signal injected into the grid circuit of V_1 will control the phase of the output square wave, although it will control the frequency only to a small extent.

From the foregoing analysis, it becomes evident that the frequency and phase stability of the circuit of Fig. 2 depend almost entirely upon the characteristics of the tuned circuit L_1-C_2 , and that variations in electrode voltages, tube characteristics, and component values exert only a very minor effect. Similarly, the oscillator stability is increased in direct proportion to the Q of the stabilizing circuit (with a fixed value of R_1). Practical considerations relating to the inherent stability of the tuned circuit itself dictate use of only moderate operating Q 's, and it has been found that values of the order of 20 to 30 are more than adequate for stabilizing multivibrators in the 1000 to 50,000 cycle range for the operating conditions likely to be encountered in practice.

Shown in Fig. 3 is a practical two-stage decade frequency-divider designed along the principles outlined above. The circuit values given are for use with type 6J6W dual triodes; selection of this type of tube was based upon reasonably high μ and G_m , and good uniformity of characteristics. Other tube types such as the 12AT7 or the 12AU7 would doubtless be equally suitable. Operating at a plate voltage of +150 volts,

Table 1. Major operating characteristics of the secondary frequency standard.

Measured at "Pulse Output" Terminal	
Pulse rise time, 10-90%:	0.12 μ sec.
Length of pulse train:	2.0 "
Spike amplitude, peak-to-peak:	
(kc.)	(volts)
100	80
50	110
10	108
5	80
1	80
1000	36
10,000	27
Square-wave amplitude, peak-to-peak:	
100	12
50	15
10	13
5	13
1	14
Measured at "Audio Output" Terminal	
Sine-wave amplitude, r.m.s.:	
(kc.)	(volts)
100	7.0
50	5.0
10	8.0
5	4.5
1	7.0
Heterodyne detector sensitivity: 0.1 v. r.f. input for 6.0 mw. audio output; frequency range, 100 kc. to 50 mc.	

the entire counter chain draws a total current of 16 ma. and delivers upward of 30 volts peak-to-peak of square wave at any of the four submultiple frequencies.

A small portion of the 100-kc. master oscillator output is applied as synchronizing voltage to the grid of V_{2A} , providing phase stabilization for the 50-kc. and 10-kc. submultiple frequencies generated by the first divider. The specific division ratio is determined by which one of the tuned stabilizing circuits L_1-C_1 or L_2-C_2 is connected into the grid circuit of V_{2B} . These circuits are tuned to 50 kc. and 10 kc. respectively, and provide operating Q 's of the order of 22. The associated grid resistor R_{g1} is so proportioned that it represents an impedance of approximately one-tenth the dynamic impedance of the tuned circuit at resonance; this provides an improvement in multivibrator frequency stability of 15 to 20 times over the conventional circuit, while still affording an essentially square output waveform.

Output from the first counter stage is taken from the grid of V_{2B} and applied as synchronizing voltage to the second divider. This stage operates in exactly the same manner as the first, generating submultiple frequencies of 5 kc. or 1 kc., phase-controlled by the appropriate stabilizing circuits L_3-C_3 or $L_4-(C_3+C_4)$. It has proved feasible to use the same inductance for both the 5-kc. and 1-kc. tuned circuits, and to effect the change in resonant frequency by variation of the tuning capacitance. The operating Q at both frequencies is approximately 18; resulting phase stability of the 1-kc. counter is such that it is readily possible to maintain a stable subdivision of 50 times, i.e., to synchronize the 1-kc. multivibrator from the 50-kc. output of the previous stage. However, this mode of operation would not normally be used in the application at hand.

Design of the counter chain permits extremely simple switching facilities for the several output frequencies. Because the time constants of the coupling networks have virtually no effect upon the multivibrator frequency, it is possible to shift the latter over a five to one range merely by selecting the appropriate tuned stabilizing circuit. Similarly, because the first section of each dual triode functions as a conventional grounded cathode amplifier so far as its grid is concerned, either or both of the multivibrators may be disabled by opening the plate circuit of the second triode without affecting in any way the normal signal path through the chain. Hence, it is not necessary to switch the output terminal from one stage to another as the various frequencies are selected.

The waveform at the grid of the second triode of each multivibrator is essentially straight-sided, and contains spike components of moderate amplitude having repetition rates corresponding to the synchronizing frequency. On the other hand, the waveform across the resonant stabilizing circuits is nearly sinusoidal, due to the "flywheel effect" of the latter. This sine wave may be made available for external use independent of the multivibrator pulse outputs. In practice, it is necessary to remove spurious transients which result from the rapid switching action within the multivibrator; this is easily accomplished by means of simple low-pass RC filter networks. The resulting sinusoid, although not completely free of distortion, is sufficiently pure for standardizing or calibration purposes.

Complete Design

Figure 4 shows the complete schematic diagram of the secondary frequency standard, and illustrates the mixing system whereby the composite output signal is formed. A switching method permitting instant selection of any of the seven pulse output frequencies or the five sine-wave audio frequencies is also shown.

Output from the 1000-ke. oscillator V_{1A} is derived from the cathode of this tube at low impedance, and mixed with the 100-ke. signal through a resistance-capacitance wave-shaping network. The resulting signal is applied to the common cathode of the second counter V_{2A} . The 10,000-ke. oscillator output from V_{3A} , being of lower amplitude, is impressed directly upon the grid of the harmonic amplifier V_4 through a small coupling capacitor. The circuit constants are so arranged that approximately equal voltages from the three crystal oscillators appear at the grid of V_4 , the operating conditions of which are such that both positive and negative peak-limiting set in at a level of about 5 volts peak. Consequently, V_4 functions as a squaring amplifier, and the plate waveform is rich in high-order harmonics.

While seemingly overcomplicated, the switching system has been designed in such a manner that the entire counter is inoperative unless the 100-ke. synchronizing signal is present; in addition, each frequency is at all times synchronized from the one immediately above it. The individual r.f. frequencies are selected by means of switches S_1 through S_7 , while S_8 selects the appropriate sine-wave or heterodyne detector output for application to the output cathode-follower. (While not so labeled in Fig 4, it will be understood that the 10-ke. and 1-ke. positions of S_8 may also be 50 ke. and 5 ke., depending upon the switch setup in the counter.) Selection of the appropriate resonant stabilizing circuits in the frequency divider is accomplished automatically, and the interlocked switching provides entirely foolproof operation.

The self-contained power supply is entirely conventional and provides +270 volts at 50 ma., and regulated +150 volts at 25 ma., simultaneously. The 4- μ f. filter capacitor across the OA2 regulator tube is necessary in order to reduce the internal impedance of the counter plate supply, thus preventing interaction between the 10-ke. and 1-ke. multivibrators through common coupling.

Fig. 5. Self-contained power supply of the frequency standard.

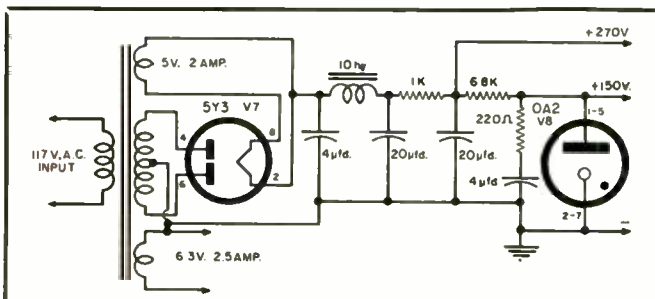

ZOPHAR

WAXES COMPOUNDS

Zophar waxes, resins and compounds to impregnate, dip, seal, embed, or pot, electronic and electrical equipment or components of all types; radio, television, etc.

Cold flows from 100°F. to 285°F.

Special waxes non-cracking at -76°F.

Compounds meeting Government specifications, plain or fungus resistant.

Let us help you with your engineering problems.



ZOPHAR MILLS, INC.
112-130 26th Street,
Brooklyn 32, N. Y.

RESINITE

EMBOSSED COIL FORMS

.. can increase
efficiency of
your iron core
insertion
production
by 20%



Special embossed construction eliminates torque control problems and stripping. Custom fabrication to your exact specification assures correct dimensions to within the most critical tolerances.

We will furnish—without charge—a pilot production run of custom-made embossed forms to fit your particular application.

Contact us now for full details about this special offer. Request technical bulletin, *Use of Threaded Tubes, Threaded Iron Cores VS. Torque Control.*

**RESINITE
CORPORATION**

Sales Representatives in:

- | | |
|---|---|
| New England:
Framingham, Mass., Framingham 7091 | Philadelphia:
Philadelphia, Pa., Chestnut Hill 8-0282 |
| New York, New Jersey:
Jersey City, New Jersey,
Journal Square 4-3574 | Northern Ohio, Western Pennsylvania:
Cleveland, Ohio, Atlantic 1-1060 |
| Upstate New York:
Syracuse, N. Y., Syracuse 76-8056 | Indiana, Southern Ohio:
Logansport, Indiana, Logansport 2555 |
| Maryland:
Baltimore, Maryland, Plaza 2-3211 | Missouri, Southern Illinois, Iowa:
St. Louis, Missouri, Sterling 2318 |
| | California:
Pasadena, California, Sycamore 8-3919 |

Canada: Montreal, Quebec, Canada, Walnut 2715

**Division of
PRECISION PAPER TUBE COMPANY**
2035A W. CHARLESTON ST. • CHICAGO 47, ILLINOIS

NEW PRODUCTS

PULSE GENERATOR

Continuously adjustable pulse durations from 0.2 to 60,000 μ sec. are attainable with the Type 1217-A unit pulser announced by *General Radio*



Company, 275 Massachusetts Ave., Cambridge 39, Mass. A small, economical instrument, the pulser is powered by the Type 1203-A unit power supply to which it is easily attached. A self-contained oscillator drives the output at 12 fixed frequencies from 30 cycles to 100 kc., and provision is made for external triggering at any frequency below 100 kc.

The Type 1217-A unit pulser is capable of approximating all three basic pulse-source waveforms: impulse, step function, and periodically repeated pulse of adjustable duration. It has a pulse rise time of less than 0.05 μ sec. and a fall time of about 0.15 μ sec.

PRECISION RATIO METER

Accurate determination of either impedance ratios or absolute values of resistors can be made with the new precision ratiometer announced by *Cal-*



Tronics Corporation. The measuring networks are designed to permit maximum versatility of application and flexibility of test setup.

This precision ratiometer has two resistive networks that may be used

separately or in conjunction with each other, a transformer for either a.c. inputs or for use as an a.c. null detector, a microammeter for d.c. measurements, and a calibrated capacitor to null out reactive components.

An illustrated bulletin giving detailed characteristics may be had by writing to *Cal-Tronics Corporation*, 11307 Hindry Ave., Los Angeles 45, Calif.

"SMALL-SIZE" ELECTRONIC COMPUTER

Because of its comparatively low cost, small size, and versatility, the new electronic "brain" announced by *Burroughs Corporation*, Detroit 32, Mich., is expected to bring electronic



computing techniques within the reach of a much wider range of users. Contained in a cabinet the size of a normal desk, it can be operated without special training and is intended for potential use in business routines as well as in engineering and scientific computation.

The *Burroughs E101* has an internal memory unit of the magnetic drum type which stores such information as tables of interest rates, logarithms, and intermediate results of computations. When needed for processing, the information is automatically transferred to the computing mechanism, or other components. The *E101* is capable of adding two 12-digit numbers in 2/1000 of a second, and will also subtract, multiply and divide.

MAGNETIC-PARTICLE TEST UNIT

The "Portaflux" is a magnetic-particle test unit designed to locate sur-

face defects in rough castings, bar stock, forgings and shop welds. Announced by the Research & Control Instruments Division, *North American Philips Company, Inc.*, 750 South Fulton Ave., Mount Vernon, N. Y., it weighs only 45 pounds and can be easily

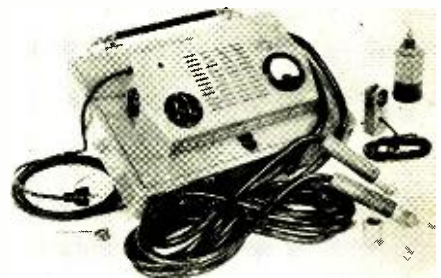

carried into a manhole or other confined spaces.

Objects to be checked are magnetized either by passing a current directly through the metal or through a surrounding cable in the form of a coil. Magnetic iron oxide or precipitated iron powder is distributed over the surface of the magnetized object and alignment of the particles is such that defects can be clearly located.

Two heavy-duty, oil-resistant insulated cables with renewable prods carry currents up to 600 amperes at a maximum voltage of 1.5 volts. A special metal coupler is provided for connecting the prods together when it is desirable to use the wrap-around coil method.

ARBITRARY FUNCTION GENERATOR

Originally designed as a high-precision analog computer component, the Type G-1A arbitrary function generator is also well suited for handling

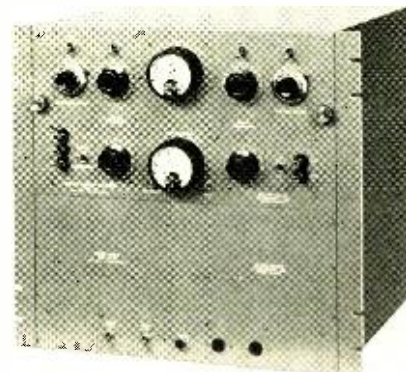

nonlinearities such as those encountered in missile telemetering (FM-FM) and recording systems. It is a special form of amplifier whose output signal can be related to input by any predetermined, arbitrary function of the form $y = f(x)$. Signal components from zero frequency to several kc. can be handled.

Now available from *William Miller Instruments, Inc.*, 325 N. Halstead Ave., Pasadena, Calif., the Type G-1A has sufficient gain to permit operation with input signals as low as 0.1 volt for full scale. Output can provide up to ± 100 volts or ± 0.015 amperes full scale. Controls permit both input and output sensitivity adjustment over a 100:1 range.

FREQUENCY METERS

Ranges covered by the new line of field test frequency meters announced by *Frequency Standards*, Box 504, Asbury Park, N. J., are 900-1200, 1200-1700, 1700-2300, 4400-5800 and 5800-8200 mc. Accuracy of Models 1217 and 1723 is .02%, for all others .01%. Usable indications on the self-contained

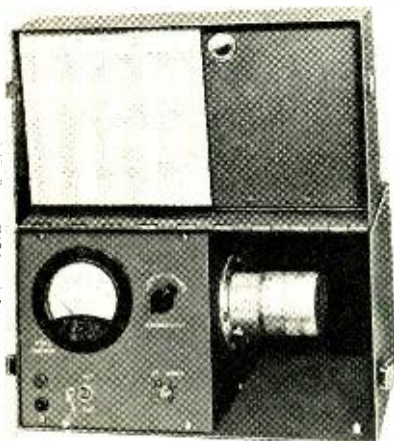

microammeters are obtained with 1-mw. inputs.

Each frequency meter, individually calibrated and supplied with charts and curves, is mounted in an aluminum carrying case designed to protect the microammeter. All models have type BNC input and accessories—such as coax-to-wave guide transducers and cables—which are available for particular requirements. The frequency-determining elements are made of Invar to keep the temperature coefficient of the instruments as low as possible.

INFRASONIC VOLTMETER

Features of the Model 316 voltmeter include high input impedance, freedom from line disturbances, a logarithmic voltage scale, and excellent long-term stability. It has been developed by *Balantyne Laboratories, Inc.*, Boonton, N. J., primarily for the measurement and monitoring of small potentials in ultra-low frequency systems such as servomechanisms and geophysical equipment.

A range of 20 mv. to 200 v. peak-to-peak is read directly on the Model 316
(Continued on page 39)

Wind Your Coils on the BEST PRECISION COIL BOBBINS

Exact quality control and finest materials add up to make PRECISION BOBBINS the best cores for R.F., I.F. coils, solenoids, switches, and other electronic applications.

Count PRECISION BOBBIN advantages:

- Greater Insulation
- Better Heat Dissipation
- Higher Moisture Resistance
- High Strength, Light Weight
- More Winding Space
- Low Unit Cost

PRECISION COIL BOBBINS can be designed to your particular specifications . . . any size, shape, quantity—dielectric kraft, fish paper, cellulose acetate, combinations or phenol impregnated materials. Flanges plain or fitted with leads, slots, holes for terminal wires . . . recessed or embossed to fit any mounting.

Send specifications for free sample and ask for Bobbin Catalog.

Also Mfrs. of PRECISION Paper Tubes

PRECISION PAPER TUBE CO.

2063 W. Charleston St. Chicago 47, Ill.
Plant No. 2: 79 Chapel St., Hartford, Conn.

PLASTIC DIALS

Printloid has been supplying dials to the leaders in the electronic industry for 18 years. Printing, die cutting, forming and machining.

COMPLETE PLASTIC PRODUCTION FACILITIES . . . ALL UNDER ONE ROOF

Including machining of Nylon, Kel-F, and Teflon. Specializing in dials, dial windows, and printed circuits.

All custom work to your specification.

Write for brochure

Printloid INC.
PLASTIC FABRICATION
Dept R 93 Mercer St.
New York 12, New York

NEED INSTRUMENTS TO SOLVE ELECTRONIC PROBLEMS?...

RADA-SWEEP Radar & Amplifier Alignment

MEGA-MATCH Measurement of Reflector Coefficient

MEGA-PULSER Transient Testing Video Amplifiers

MARKA-SWEEP RF-TV Tuner Alignment

RADA-PULSER Radar & Transient Testing

CALIBRATED WIDE-RANGE SWEEPING Oscillator Single Dial Tuned

CONSULT THIS LATEST 64-PAGE CATALOG

ELECTRONIC INSTRUMENTS

Write **KAY ELECTRIC CO.** FREE

4 MAPLE AVE. PINE BROOK, N. J.

NEW LITERATURE

MICROWAVE TEST EQUIPMENT

The Electronics & X-Ray Division of *F-R Machine Works, Inc.*, 44-14 Astoria Blvd., Long Island City 3, N. Y., has announced publication of a catalog showing its full line of precision microwave test equipment. Units include precision slotted sections, a broadband probe, a double-stub tuner, direct-reading frequency meters, standard mismatch, series and shunt tees, hybrid tees, wave guide bends, spectrum analyzers, a standing wave amplifier, and transmission line stands.

QUARTZ CRYSTAL UNITS

Quartz crystal units ranging in frequency from 16 kc. to 100 mc. and including the new RH-7BTV designed specifically for use in color television are described in a four-page bulletin released by *Reeves-Hoffman Corporation*. Comprehensive data pertaining to dimensions, frequency range, and corresponding military specifications are

given in this bulletin, which may be obtained by writing to Mr. Carroll Rahn, *Reeves-Hoffman Corporation*, Cherry and North Sts., Carlisle, Pa.

PRINTED CIRCUITS

The availability of a four-page bulletin on "carry-through" printed circuits has been announced by *Insulated Circuits, Inc.*, 115 Roosevelt Ave., Belleville, N. J., an approved licensee of *International Telephone and Telegraph Company* for the manufacture of printed circuit microwave components. Among the many facets of printed circuit production discussed in Bulletin No. 106 are insulating base materials, conductive patterns and plating. Detailed photographs and drawings are included.

GERMANIUM DIODES

Comprehensive data on the *IRC* Type 1N series germanium diodes are given

in a two-page leaflet which covers both standard and replacement types, construction, application and dimensions. Write to *International Resistance Company*, 401 N. Broad St., Philadelphia 8, Pa., for Catalog Data Bulletin N-1.

MICROWAVE COMPONENTS

Facilities for the design and manufacture of coaxial line and wave guide components to electrical specifications or manufacturing drawings are offered in an eight-page brochure issued by the *Diamond Microwave Corporation*, 7 North Ave., Wakefield, Mass. Many examples of the type of component being fabricated by this company are presented and discussed.

RCA LITERATURE

In requesting any of the following literature from the Engineering Products Division of *Radio Corporation of America*, Camden 2, N. J., the catalog sheets must be specified by number. If the material on "building block" microwave units is desired, the request should appear on a company letterhead.

Catalog sheets C.5061-66 inclusive, C.5070, C.5073, C.5074, and C.7134 describe "building block" equipment units for *RCA's* CW-20 microwave radio relay communications systems. The rela-

ELECTRONIC DATA PROCESSING MACHINE

DEVELOPMENT of an electronic data-processing machine, said to be the fastest and most flexible commercial processing system ever devised, has been announced by *International Business Machines Corp.*, 590 Madison Ave., New York 22, N. Y. Called the Type "702," the new machine has been designed from the ground up for business use,

and is expected to find wide application in accounting and statistical work.

The "702" is made up of a central arithmetical and logical unit capable of performing more than ten million operations in an hour. Working partner of this unit is a bank of cathode-ray "memory" tubes. Reels of magnetic tape, each with a capacity roughly

equivalent to all the numbers in the 1850 pages of the Manhattan telephone directory, feed data to the machine and write down the answers at the phenomenal rate of 15,000 letters or numbers a second. Punched card readers, punches, and line printers are also provided.

This system is controlled by means of a so-called "stored program," which is no more than a finely detailed list of instructions translated into a language which the machine understands. The machine retains these instructions in its memory and refers to them, one by one, at lightning-like speed. Actual writing of the instructions and converting them to machine language is said not to be difficult, but the analysis of office operations which is a necessary preliminary step can run into months, or even years, of study. Surprisingly, the logic of commercial problems, considered as a whole, is much more involved than the logic of scientific problems—due primarily to the much greater variety of input and output data in business situations and the many exceptions to the rules for handling them.

It is expected that equipment of this kind will go far in enabling business to take advantage of new management techniques, generally mentioned in terms of "linear programming" and "operations research." These techniques deal with the expression of business situations in terms of mathematics and can bring about more efficient and profitable use of production and distribution facilities.

Partial view of the many interconnected units making up the Type "702."



The leading quartz crystal developments of the past 25 years have been produced by Standard Piezo!

For an exact match of exacting specifications, it pays to choose frequency control crystals from the world's largest, most complete line . . . fully tested and proved in the world's most critical services.



NEW 20-PAGE CRYSTAL CATALOG SENT ON REQUEST

STANDARD PIEZO COMPANY
Carlisle, Pa.



STANDARD PIEZO Crystals

THE LINE THAT SETS THE QUALITY STANDARDS



tionships between the standard equipment units are explained by text and illustrations.

Microwave station assemblies available from RCA are described and illustrated in catalog sheets C.5101-02-03-10-12-14-22-24, while microwave transmission line and accessories are covered in C.7040-42-43-44-45-52-53-54 and C.7102-12-13-22-25-26.

Form B.423 gives features, uses and specifications for the RCA video distribution amplifier, B.424 for the pulse distribution amplifier, and B.377 for the video switcher.

PULSE TRANSFORMERS

Electrical and physical characteristics of 33 blocking oscillator or regenerative driver pulse transformers are listed in a catalog available from *Utah Radio Products Co., Inc.*, Huntington, Ind. Four general types of transformers are described, and typical circuit diagrams are given.

TOROIDAL COILS AND COMPONENTS

Toroidal coils and components illustrated and described in a four-page brochure available from *Torwico Electronics, Inc.*, include a fine wire-wound choke, a miniature magnetic amplifier coil, high temperature choke, balanced C.T. high-Q choke, large coil, miniature choke, stable oscillator coil and a low-pass filter.

For a copy of this brochure, write to *Torwico Electronics, Inc.*, 961 Frelinghuysen Ave., Newark 5, N. J. Inquiries are invited on particular needs or problem applications.

CALENDAR of Coming Events

AUGUST 25-27—WESCON (Western Electronic Show and Convention), Pan-Pacific Auditorium and Ambassador Hotel, Los Angeles, Calif.

SEPTEMBER 15-17—Symposium on Information Theory, Massachusetts Institute of Technology, Cambridge, Mass.

SEPT. 30-OCT. 1—Fifth Annual Meeting of the IRE Professional Group on Vehicular Communications, Rice Hotel, Houston, Texas.

OCTOBER 4-6—National Electronics Conference, Hotel Sherman, Chicago, Ill.

OCTOBER 11-15—AIEE Fall General Meeting, Morrison Hotel, Chicago, Ill.

OCTOBER 13-17—Annual Convention, Audio Engineering Society, Hotel New Yorker, New York, N. Y.

OCTOBER 14-17—Audio Fair, Hotel New Yorker, New York, N. Y.

KINESCOPE RECORDING

with **Guaranteed Results!**

OR YOUR MONEY BACK

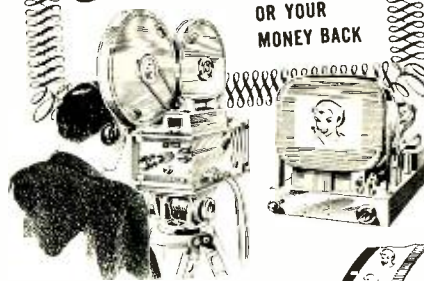

NOW, A DUAL-PURPOSE
Auricon
"SUPER 1200" CAMERA
with TeleVision-Transcription
"TV-T" Shutter...

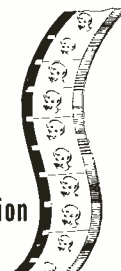

...designed for Kinescope Recording...and also shoots regular Live Action 16 mm Sound-On-Film Talking Pictures with no Camera modification! The "Super 1200" Camera with "TV-T" Shutter (Pat. Appl'd. for 1949) can Kinescope Record a 30 minute continuous show using 1200 foot film magazines. Write today for information and prices.

USE AURICON "TV-T" KINESCOPES FOR:

- ★ DELAYED RE-BROADCASTING
- ★ SPONSOR PRESENTATIONS
- ★ COMPETITION CHECKS
- ★ PILOT KINESCOPES
- ★ SHOW-CASE FILMS
- ★ "HOT KINES"
- ★ AIR CHECKS

Auricon 16 mm Sound-On-Film Cameras are sold with a 30-day money-back guarantee. You must be satisfied!

Auricon 50 ft. Kinescope "TV-T" Demonstration Films are available on loan to TV Stations and Film Producers. Please request on your letterhead.



BERNDT-BACH, INC.

6928 Romaine St., Hollywood 38, Calif.

MANUFACTURERS OF SOUND-ON-FILM RECORDING EQUIPMENT SINCE 1931

Radio Licensees

(Continued from page 12)

the state to handle administrative traffic over its proposed microwave point-to-point system. Telephone companies have vigorously opposed this petition on the grounds that this kind of competition with the carriers would divert their revenues, burden the taxpayers, and constitute government operation in a field where private enterprise could—and should—do the job. Significantly, many states which had initially supported California in this cause subsequently withdrew their comments.

"A less obvious, but related, competitive phenomenon is revealed by the intensified and more complex use of leasing and maintenance arrangements in the conduct of operations on frequencies allocated to user groups. Actually, this device has long been with us. For years, some users have handled their communications by leasing equipment and contracting with others for its maintenance. In these arrangements, the user obtains the license on frequencies for which he is eligible. To date, our main problem in this connection has been to insure and insist that any such arrangements in no way affect or limit the licensee's control of his stations, or in any way purport to relieve him of his responsibility under the Communications Act and the Commission's Rules and Regulations. With increasing activity by common carriers in

this leasing field, the particular problems have become especially difficult. The contracts between user and common carrier have sometimes been so drawn as to place restrictions of various kinds on the user and to reveal that the carrier, in some instances, fundamentally regarded this situation as no different from that in which it rendered communication service through facilities of its own on frequencies assigned to it. We have consistently compelled the deletion of clauses which appeared to fetter, or render ambiguous, the licensee's position. Yet only recently I heard a story, which might be apocryphal, of an industrialist who—in replacing his company-owned and operated system with one provided on user frequencies by common carriers—remarked that he was not in the communications business, knew nothing about it, and was glad to turn over his responsibilities in that regard to experts. Now, of course, the fact is that while such a person would be entirely free to obtain any services available from common carriers he could never turn over to others one iota of the responsibility inherently attaching to the licenses and frequency assignments which he or his company directly hold. This is not simply a matter of documents or casual representations. In practice, if full, actual, unequivocal control is not retained by the licensee of a station, that licensee jeopardizes his right and status as a licensee.

"I turn now to a more difficult aspect of this problem which, I gather from the questions of some of your representatives, you find deeply troubling. The preferential frequency allocations of groups such as yours were predicated on the claim of need for direct, private, operational control of radio communications which could only be satisfactorily provided by setting up your own service on frequencies allocated for your purposes. I suppose that the special problems of the microwaves, with their point-to-point features, and many possibilities for the combining of microwaves, wire lines, mobile units and exchange facilities into elaborate systems, have intensified interest in this question. You may ask yourselves—assuming the contracts are clear and valid on their face—what are the actual operating conditions and what, if any, are their categorical implications as they affect the basis on which frequency allocations were obtained? As to this, I can only comment that if arrangements of this kind do not in any sense negate the user's obligations or the concept of direct operational control of his facilities, there would appear to be no disability attaching to this way of obtaining service. You gentlemen undoubtedly know better than I what actually happens under continuing operating conditions.

"Assuming that your control is adequate in a legal sense, you might ask yourselves some further questions. If your supplier, in one of these arrangements, should shut down for any reason, would you be able to function and to use your radio as a directly needed operating tool? Again, suppose your operations are entwined in an elaborate system, and at the end of a contract period your supplier withdraws his facilities or imposes unacceptable terms. Would you find yourself in such a dependent or unprovided-for position as to be unable to meet the situation in any reasonable manner? What if, in general, these arrangements extend to the point where there is little or no difference in substance between the situation in which a common carrier renders service directly on its own frequencies and that in which it provides facilities for operation on the user's frequencies? With exploitation of the microwaves, a number of new possibilities come into force. When the user obtains from others the coordinated integrals for an extensive system involving various combinations of facilities, are there in reality no changes in his position? If his role evolves to the extent that he simply talks over the phone and signs applications, he may have reached the point where his basic position rests on a fiction. What's more, it may be a fiction which is not even

TV-AM-FM SET PRODUCTION

Information based on latest reports from RETMA.

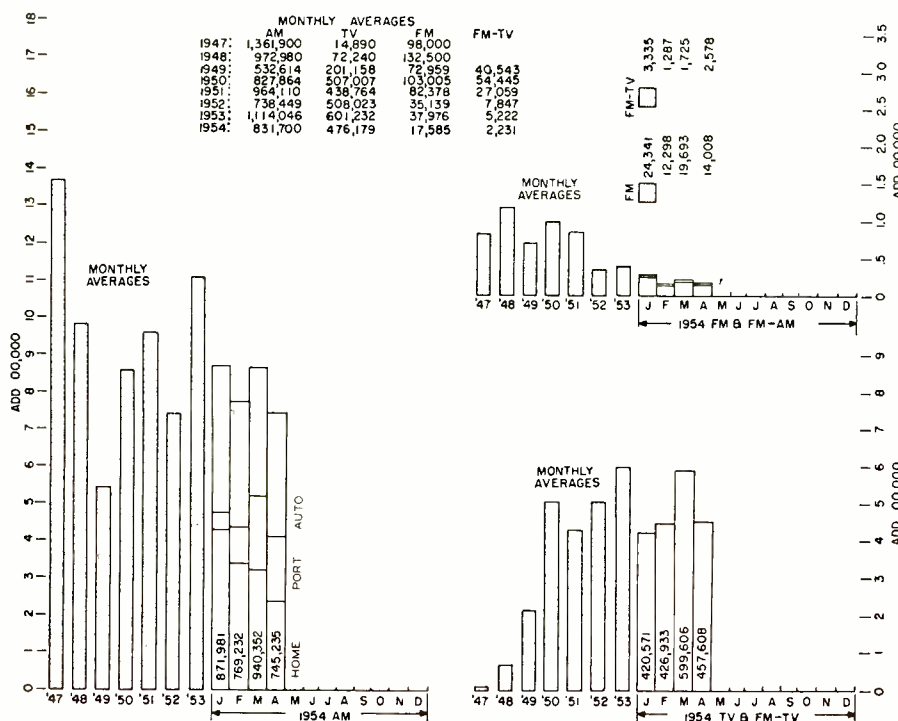

Professional Directory

GEORGE P. ADAIR Engineering Co. Consulting Engineers

Radio, Television, Communications,
Electronics
1610 Eye St., N.W. EXecutive 3-1230
Washington 6, D. C.

Paul W. Klipsch
Professional Engineer
Acoustic development
and consulting

Klipsch and Associates
building the authentic
KLIPSCHORN
world's finest sound reproducer

Hope, Arkansas Tel. Hope PRospect 7-3395

FRANK H. McINTOSH

Consulting Radio Engineer

1216 Wyatt Bldg., Washington 5, D. C.
MEtropolitan 8-4477
Member AFCCE

MEASUREMENTS CORPORATION



Research &
Manufacturing
Engineers

Harry W. Houck John M. Van Beuren M. A. Honnell
Specialists in the Design and
Development of Electronic Test Instruments
BOONTON, N. J.

GABRIEL ELECTRONICS DIVISION



Formerly Workshop Assoc. Div.
THE GABRIEL COMPANY

Specialists in
High-Frequency
Antennas

Endicott St. Norwood, Mass.
Norwood 7-3300

RATES FOR PROFESSIONAL CARDS IN THIS DIRECTORY

Single insertions—\$24.00
6 times—\$21.00 per insertion
12 times—\$18.00 per insertion

useful. Useless fictions will not endure, and sooner or later allocations and regulations will come to reflect the realities. The arrangements must be able to stand direct scrutiny. If the representations upon which a group secures its preferential frequency allocations should, in any substantial respect, be found not to reflect actual present conditions, it would become necessary to re-examine the foundations on which that group's frequency allocations are predicated.

"Another set of implications arising out of these arrangements has been suggested to me. Equipment and maintenance contracts may satisfy our control requirements, and operating conditions likewise may present no specific problems of control. Assume that over the years more and more of the systems do, in fact, pass into the operating orbit of the common carriers. The resemblance between service provided by the common carriers on their own frequencies and that provided by them on user channels under leasing arrangements may become so close as to be indistinguishable. Well, that is a highly speculative area. I am not in a position to say whether the prospect posed by the hypothesis is good or bad, inevitable or even likely. But I have been asked to say something about it. I can only venture the following, strictly analytical, personal comment. If it should come to pass that the majority of systems reach the condition assumed in the hypothesis, the Commission's direct licensing of users may in the process have lost much of its meaning. Moreover, the capacity of those interested in private services to defend their private user concept might be weakened to the point where their arguments bear little weight.

"We cannot tell your industries what they must do or how they should obtain their communications. But, in response to demand, we have provided special preferential allocations. We are now working out the allocations in the microwaves. In both of these matters, we have had to consider the important factor of efficient frequency utilization in relation to the factors of need for safety and operational efficiency by public protective agencies, in air, land and sea transport, and for a variety of other industrial uses. What happens to the private user method of obtaining communications will, in the long run, depend on the user himself. If he delegates his authority and responsibilities, the privileges to which those elements attach will some day pass from him. In all these matters, the important thing is to know what we are doing and where we are going, and—so far as possible—to intend the results of our courses of action."



Extra Rugged—Light Weight HIGH ARTICULATION E.V. Mobile-Mikes

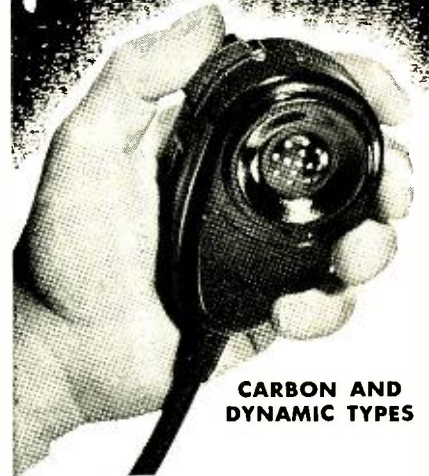

**CARBON AND
DYNAMIC TYPES**

E.V. Mobile-Mikes are designed for the ultimate in speech transmission! You get high intelligibility, high output, more usable power level, less listener fatigue and other E-V features. *Proved in toughest service.* Used in public safety, aircraft, railroad and government communications. High impact phenolic case. Permanent finish. Weighs as little as 7 oz. Model 210 Carbon lists at \$28.50. Model 600-D Dynamic lists at \$38.50.

EXACT REPLACEMENT

Carbon Mobile-Mikes also available for exact replacement in current Motorola, RCA, G.E. and similar equipment. You get full advantage of E-V design and performance features.



NOISE-CANCELLING DIFFERENTIAL*



Close-talking, carbon type. Assures clear speech transmission under high ambient noise in any weather or climate. Blast-proof, waterproof, shock-resistant. Model 205 lists at \$38.50. Model 602 Differential Dynamic at \$49.50 list. (*Patent No. 2,350,010)

Send for Bulletin!

Electro-Voice

BUCHANAN, MICHIGAN
Export: 13 E. 40th St., N.Y. 16, U.S.A., Cables: Arlab

AUTHORIZED DISTRIBUTORS EVERYWHERE

Personals

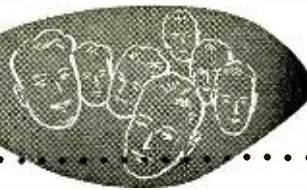

BENNETT ARCHAMBAULT, formerly vice president and general manager of the *M. W. Kellogg Company*, has now been elected president and a director of *Stewart-Warner Corporation*, Chicago, Ill. During World War II, Mr. Archambault headed activities in the European Theater of Operations for the Office of Scientific Research and Development; for this work he was awarded the Medal for Merit, the highest decoration attainable by a civilian.



DR. CHARLES C. BRAMBLE has been named to the technical staff of the Research and Development Division, *Norden Laboratories Corp.*, White Plains, N. Y., and Milford, Conn.; he will be a consultant in the fields of applied mathematics, mechanics, ballistics and computation, and will also be connected with the coordination of major laboratory projects. Dr. Bramble was previously director of research at the Naval Proving Ground, Dahlgren, Va.



DR. DANIEL E. CLARK, research engineer in charge of transistor development for *Automatic Electric Company*, Chicago, Ill., has been promoted to chief electronics engineer—an executive position newly created for the direction of its enlarging electronics activity. An active member of the IRE and WSE, Dr. Clark received his Ph.D. in physics from Northwestern University, where he has also served on the faculty as an instructor in electronics.



ARTHUR W. HOLT of the National Bureau of Standards has received the Department of Commerce Silver Medal for Meritorious Service for "a major contribution of unusual value to science and technology in the original design and construction of a new high-speed memory for electronic data processing machines." His device has high reliability and very rapid random access, important qualities for advancement of computer techniques.



E. B. JONES will be the chief engineer in charge of estimating and engineering in the new Field-Erected Equipment Division of *Lindberg Engineering Company*, Chicago, Ill., which has been formed to expand facilities for specializing in large, field-erected industrial furnaces, special machines and complete production lines. Mr. Jones, who recently resigned from *Continental Industrial Engineers Inc.*, has had 25 years of experience in this field.



R. A. KIMES, who joined the *American Machine & Foundry Company* in 1946, has now been named director of engineering of the *AMF Electronics Division*, Boston, Mass. During the intervening time, Mr. Kimes served as director of overseas project contracts for the International Division, assistant manager and manager of the Engineering Division's Special Products Department, and most recently, as manager of the *AMF General Engineering Laboratories*.

Cincinnati Conference

(Continued from page 20)

feeds may be used, since the output of only one camera is transmitted at any given time.

A NEW APPROACH TO SERIES HEATER STRINGS FOR TELEVISION, Frank Roberts, *Emerson Radio and Phonograph Corporation*

One of the major sources of tube failures in heater tube strings is the presence of voltage surges. Tubes from different manufacturers may behave differently. A method of tube evaluation outside the heater string has been developed which enables prediction of surge conditions. By proper tube selection, surge-free operation can be obtained. However, this selection does not provide for trouble-free operation in the event of field tube replacement. It is necessary to establish industry standardization of heater characteristics to eliminate all trouble.

INTERFERENCE TO COLOR AND MONOCHROME TELEVISION RECEIVERS BY OSCILLATOR RADIATION AND OTHER CW SIGNALS, E. W. Chapin, Willmar K. Roberts and Lawrence C. Middlekamp, Federal Communications Commission; presented by Mr. Roberts

Observers were used to check effects of interfering signals having various frequencies and amplitudes. It was found that a monochrome signal can tolerate interference 25 to 30 db stronger when the interference falls in the upper part of the channel as compared with the level which may be tolerated near the picture channel. NTSC color TV does not enjoy this advantage.

DESIGN CONSIDERATIONS FOR A 12.5 KW TV AMPLIFIER IN THE UHF BAND, E. Bradburd, A. Cortizas and L. Rosenberg

Careful consideration of all factors involved led to the use of a Type 3K-50,000 klystron for the power output tube. This tube can provide a peak power output of 12.5 kw., with adequate linearity. A total of six cavity sets is necessary to cover the u.h.f. band, each set covering 17% of the entire band. Bandwidth, phase response and linear-

PHOTO CREDITS

PAGE	CREDIT
7, 8	General Electric Co.
10	Lenkurt Electric Co.
13, 15 (bottom)	Radio Corporation of America
14, 15 (top)	PSC Applied Research

ity in the final transmitter are satisfactory for color TV.

SEMICONDUCTOR DIODES FOR TV RECEIVERS, Joseph P. Roveto, *Raytheon Manufacturing Company*

Germanium and silicon diodes have somewhat different characteristics. A small, optimized bias voltage will usually reduce the noise factor of germanium, while not affecting selenium. Germanium will operate better at low oscillator injection levels, thus reducing oscillator radiation. *Raytheon* has built mixer diodes in its laboratories with noise figures as low as 7 db. Production is a year or so off, but such units can be mass-produced.

Harmonic generators or multiplier crystals are being used in the new "Strip Tuner," with u.h.f. conversion direct to the i.f. frequency. The CK715 was designed particularly for high third and fourth harmonic generation, and the reliability is such that it may be soldered into the circuit.

The CK706A hermetically sealed unit is manufactured primarily for video detector use. Gain-bandwidth of this crystal is very constant and once designed into a circuit, the other components can be standardized.

Audio System Design

(Continued from page 9)

may be inserted as shown in Fig. 5, or—if desired—the master gain control setting loss could be increased to 21 db and the pad left out.

Level Adjustment

Before proceeding to the monitor circuit, it might be well to consider methods of adjusting the levels so that they do come out the same. For instance, if the level out of the mixer bus were too high, a T-pad of resistors could be inserted ahead of the booster amplifier. In this case, the mixer loss would have to be recalculated as working into a resistance load. If the output of the mixer bus were too low, then rather than add another amplifier, 6 db could be picked up at each attenuator by going to T-attenuators in place of the ladders; in mixers having a large number of inputs,

the attenuators may be one to two ladders, such as 600/1200-ohm units, which have a minimum loss of 2 db. This type of ladder keeps the mixer impedance level higher so that the mixer loss is less, i.e., Z_1 is larger. The method used is determined by each individual problem encountered. As stated earlier and illustrated by the design just completed, a preamplifier having a gain of about 40 db is optimum.

Monitor

For program monitoring, a bridging transformer (15-db bridging loss) will be employed across the program line just ahead of the line pad, as shown in Fig. 5. Using a program/monitor amplifier as a monitor amplifier, the output rating would be +29 vu. Using a 600/600-ohm, 20-step, 2 db per step ladder attenuator and extending the levels in Fig. 5, it is evident that a pad will be needed to match levels. A 10-db 600/600-ohm T-pad completes the design.

REFERENCE:

1. Chinn, H. A., "Measurement of Audio Volume," *Audio Engineering*, September and October, 1951.

New Products

(Continued from page 33)

in four decade steps, with an accuracy of 3% throughout the spectrum of 0.05 cps to 30 kc. Pointer flutter is negligible down to 0.05 cps, while discharge of the storage circuits for a rapid sequence of readings may be effected by a reset device.

PULSE TRANSFORMERS

Two subminiature pulse transformers have been announced by the *Atlantic Transformer Corporation*, 30 Hynes Ave., Groton, Conn., which utilize advanced pulse winding techniques and high permeability pulse cores. Known as PM1A and PM1B pulse transformers, each is hermetically sealed in a 7/8"-diameter flanged case 1 1/16" high.

PM1A is rated for a 1 to 3.5 μ sec. pulse width, 5% droop and .06- μ sec. rise time, while PM1B is similar to PM1A but is rated for a 0.3 to 1 μ sec. pulse width.

INDEX OF ADVERTISERS

NAME	PAGE	NAME	PAGE
Adair Engineering Co., George P.	37	Measurements Corporation	37
Amperite Co., Inc.	4	Monitorradio Radio Apparatus	27
Berndt-Bach, Inc.	35	Motorola Communications & Electronics, Inc.	Fourth Cover
Cannon Electric Co.	19	Precision Paper Tube Co.	33
Chicago Standard Transformer Corp.	25	Printloid Inc.	33
Cornell-Dubilier Electric Corp.	27	Radiart Corporation, The	29
Eitel-McCullough, Inc.	3	Radio Corporation of America	6, 21
Electro Motive Mfg. Co., Inc., The	5	Resinite Corporation	31
Electro-Voice	37	Rohn Manufacturing Company	39
Gabriel Company, The	37	Safety Tower Ladder Co.	39
Hammarlund Manufacturing Co., Inc.	23	Standard Piezo Co.	35
Kay Electric Co.	33	United Transformer Co.	Second Cover
Klipsch & Associates	37	Zophar Mills, Inc.	31
McIntosh, Frank H.	37		

YOU CAN'T FALL
It's a Life Saver



IT LOCKS—IT HOLDS

Prevents death and injuries from falling.

SAFETY DEVICE FOR LADDERS

Easy and inexpensive to install: Clamps to rung, peg, pole or frame. No welding or cutting. Simple to operate: No upkeep. Requires no attention from climber. Anyone can use it. Safety Specifications: High safety factor. Will not rust or corrode. Write for folder.

Safety Tower Ladder Co.

1024 Burbank Blvd. P.O. Box 1052
BURBANK, CALIFORNIA

Also Manufacturers: Safety Lifeline Lock



Member

National Safety Council



ROHN
NEW No. 30
HEAVY-DUTY
COMMUNICATION
and MICRO-WAVE
TOWER

Proved in Construction, Design, and Operation

Truly the finest tower of its kind. Made of heavy-duty tubular steel, electric welded throughout. In 10-ft. sections for easy erection, 18-in. triangular design. Can be used non-guyed to 66-ft.—guyed to 200-ft.

Call your Rohn representative or write, phone or wire:
"Pioneer designers and manufacturers of all type towers."

ROHN MANUFACTURING CO.
DEPT. REC. • 116 LIMESTONE, BELLEVUE
PEORIA, ILLINOIS • PH. 6-9150

12 VOLT ELECTRICAL SYSTEM

These
already
have it!

NASH, OLDSMOBILE,
BUICK, CHRYSLER,
CADILLAC

How many
will have it
by 1955-
1956?

FORD, PLYMOUTH, DODGE,
CHEVROLET, PONTIAC,
MERCURY, DE SOTO,
HUDSON, STUDEBAKER

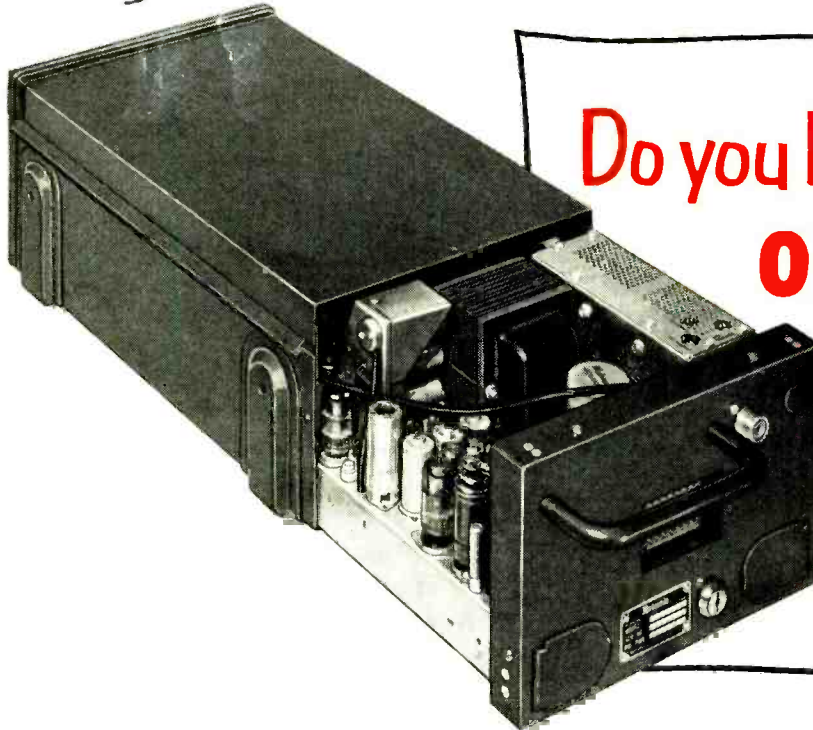

Do you have fleet radio
**OBSOLESCENCE
INSURANCE?**

Motorola

had it built-in a year ago

A growing number of automobile manufacturers are changing from 6 to 12 volt electrical systems. Motorola 2-way radio now gives you built-in protection against expensive obsolescence should any part of your fleet be affected by this trend.

WHAT IT IS—It's truly universal 6/12V equipment—2-way radio that can be interchanged in mixed 6 and 12-volt fleets without modification of power supplies, jumpers, plugs, connectors, cables or switches. When re-installing in a 12-volt car, no cable replacement is required. It is so fool proof that you can safely make changeovers in the dark without worry of burning out tubes or damaging a power supply.

FEATURES—The *all-vibrator* power supply attains over 70% power conversion efficiency with a resultant power drain reduction of up to 40%—for more power per unit size per ampere drain than any other sets on the market—all this, plus the superior performance of Motorola's famous Sensicon with guaranteed permanent selectivity and seven other exclusive features.

ACCEPTANCE—Again anticipating the trends, Motorola offers freedom from obsolescence, and superior performance at lower cost. You can easily see and hear the difference—greater signal strength, more audio power, longer battery and generator life, lower maintenance costs. You get all this in Motorola's truly universal 6/12-volt mobile units—available in the following classes:

- 25-54 mc., 25-30 and 50-60 watts R.F. output
- 144-174 mc., 10 and 25 watts R.F. output
- 450-470 mc., 18-20 watt R.F. output

Here is a partial list of Motorola 2-way Radio customers who have 6/12 volt interchangeable mobile units—

Michigan State Police	El Paso National Gas Co.
Ohio State Police	Boston Edison Co.
Shell Oil Co.	Florida State Police
Community Public Service Co.	Iowa State Police
County of Orange, Calif.	State of South Carolina



Motorola Communications & Electronics, Inc.

A SUBSIDIARY OF MOTOROLA, INC.

4501 W. Augusta, Chicago 51, Ill. • Rogers Majestic Electronics, Ltd., Toronto, Canada